



Coimisiún na Scrúduithe Stáit
State Examinations Commission

foirmlí agus táblaí

faofa lena n-úsáid sna scrúduithe stáit

$$x = \frac{-b \pm \sqrt{b^2 - 4ac}}{2a}$$

$$a^2 = b^2 + c^2 - 2bc \cos A$$

$$F = P(1+i)^t$$

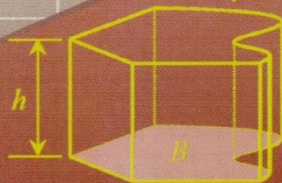

$$V = Bh$$

$$E = mc^2$$

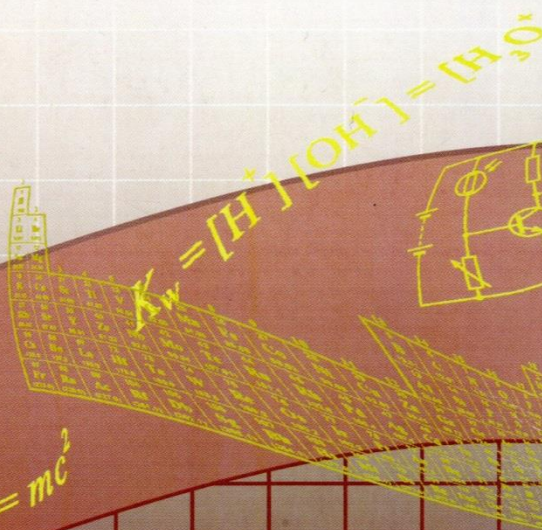

formulae and tables

approved for use in the state examinations

Clár / Contents



Foirmlí agus Táblaí

faofa lena n-úsáid sna scrúduithe stáit

Tá an leabhrán seo ar fáil ó dhíoltóirí leabhar nó díreach ón
Oifig Dhiolta Foilseachán Rialtais
Teach Sun Alliance, Sráid Theach Laighean, Baile Átha Cliath 2
nó tríd an bpost ó

Foilseachán Rialtais, An Rannóg Post-Trácta
Aonad 20, Páirc Mhiondiola Cois Lochá, Clár Chlainne Mhuiris, Co Mhaigh Eo
Fón: 01 6476834 nó 1890 213434. Facs: 094 9378964 nó 01 6476843

Praghas: €4

Formulae and Tables

approved for use in the state examinations

This booklet is available from booksellers or directly from the

Government Publications Sale Office
Sun Alliance House, Molesworth Street, Dublin 2
or by mail order from

Government Publications, Postal Trade Section
Unit 20, Lakeside Retail Park, Claremorris, Co. Mayo
Tel: 01 6476834 or 1890 213434. Fax: 094 9378964 or 01 6476843

Price: €4



Clár / Contents



© Rialtas na hÉireann
Coimisiún na Scrúduithe Stáit

www.examinations.ie

SEC167/11-V3-May2011

ISBN: 978 1 4064 2283 2



Clár / Contents



Tabhair faoi deara nach gceadaítear do chóip féin den leabhrán seo a úsáid sna scrúduithe stáit.

Beidh cóipeanna ar fáil ón bhfeitheoir agus ba chóir iad a thabairt ar ais i ndeireadh an scrúdaithe.

Note that you cannot use your own copy of this booklet in the state examinations.

Copies will be available from the superintendent and should be returned at the end of the examination.



Clár / Contents



Please send any comments or suggestions for revisions to:

dfinlayson@eircom.net



Clár / Contents



Click on the Tables you need

Clár

Contents

Fad agus achar	8	Length and area
Achar dromchla agus toirt	10	Surface area and volume
Meastacháin ar achar	12	Area approximations
Triantánacht	13	Trigonometry
Céimseata	17	Geometry
Céimseata chomhordanáideach	18	Co-ordinate geometry
Ailgéabar	20	Algebra
Séana agus logartaim	21	Indices and logarithms
Seichimh agus sraitheanna	22	Sequences and series
Tacair agus loighic	23	Sets and logic
Calcalas	25	Calculus
Eacnamaíocht	28	Economics
Matamaitic an airgeadais	30	Financial mathematics
Staitisticí agus dóchúlacht	33	Statistics and probability
Aonaid tomhais	44	Units of measurement

Clár / Contents



Click on the Tables you need

Tairisigh bhunúsacha fhisiceacha	46	Fundamental physical constants
Fisic cháithníní	48	Particle physics
Meicnic	50	Mechanics
Teas agus teocht	58	Heat and temperature
Solas agus fuaim	59	Light and sound
Optaic gheoiméadrach	60	Geometric optics
Leictreachas	61	Electricity
Radaighníomhaíocht	63	Radioactivity
Ceimic	64	Chemistry
Siombailí do chainníochtaí fisiceacha coitianta agus na haonaid ina dtomhaistear iad	65	Symbols and units of measurement of common physical quantities
Siombailí ciorcaid leictrigh	72	Electrical circuit symbols
Na dúile	79	The elements
Tábla na núiclidí	83	Table of nuclides
Dúile, sórtáilte de réir na siombailí	91	Elements, sorted by symbol



Clár / Contents



Clár / Contents

Fad agus achar

Length and area

Seasann A iontu seo a leanas
d'achar na fóirach atá i gceist.

In the following, A represents the
area of the shape in question.

Comhthreomharán

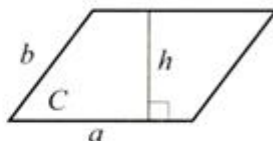

$$A = ah$$
$$= ab \sin C$$

Parallelogram

Traipéisiam

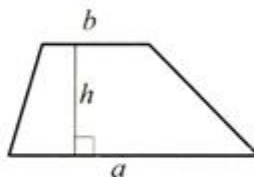

$$A = \left(\frac{a+b}{2} \right) h$$

Trapezium

Ciorcal / Diosca

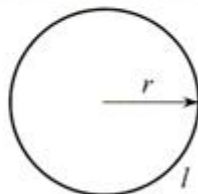

$$l = 2\pi r$$
$$A = \pi r^2$$

Circle / Disc

fad /
(imlíne l)

length /
(circumference l)



Stua / Teascóg

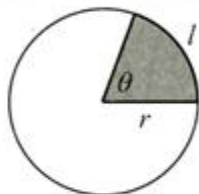

Arc / Sector

nuair is ina raidiain atá θ

$$l = r\theta$$

$$A = \frac{1}{2}r^2\theta$$

when θ is in radians

nuair is ina chéimeanna atá θ

$$l = 2\pi r \left(\frac{\theta}{360^\circ} \right)$$

$$A = \pi r^2 \left(\frac{\theta}{360^\circ} \right)$$

when θ is in degrees

Triantán

áit a bhfuil $s = \frac{a+b+c}{2}$

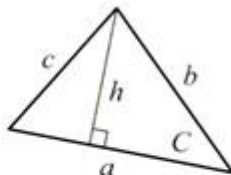

$$A = \frac{1}{2}ah$$

$$= \frac{1}{2}ab \sin C$$

$$= \sqrt{s(s-a)(s-b)(s-c)}$$

Triangle

taking $s = \frac{a+b+c}{2}$



Achar dromchla agus toirt

Surface area and volume

Seasann A iontu seo d'achar **cuar** an dromchla agus seasann V do thoirt an tsolaid atá i gceist.

In the following, A represents the **curved** surface area and V represents the volume of the solid in question.

Sorcóir

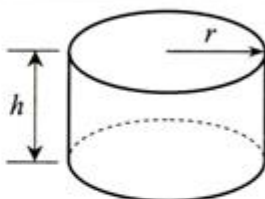

$$A = 2\pi r h$$

$$V = \pi r^2 h$$

Cylinder

Cón

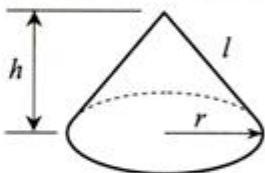

$$A = \pi r l$$

$$V = \frac{1}{3} \pi r^2 h$$

Cone

Sféar



$$A = 4\pi r^2$$

$$V = \frac{4}{3} \pi r^3$$

Sphere



Frustam cóin

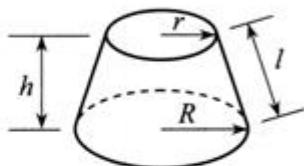

$$A = \pi(r + R)l$$

$$V = \frac{1}{3}\pi h(R^2 + Rr + r^2)$$

Frustum of cone

Solad de thrasghearradh aonfhoirmeach (príosma)
áit arb é B achar an bhoinn

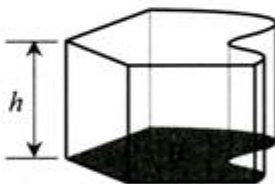

$$V = Bh$$

Solid of uniform cross-section (prism)
taking B as the area of the base

Pírimid ar bhonn ar bith
áit arb é B achar an bhoinn

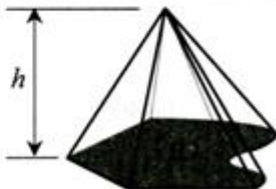

$$V = \frac{1}{3}Bh$$

Pyramid on any base
taking B as the area of the base



Meastacháin ar achar

Seasann A d'achar na fíorach.

Area approximations

A represents the area of the shape.

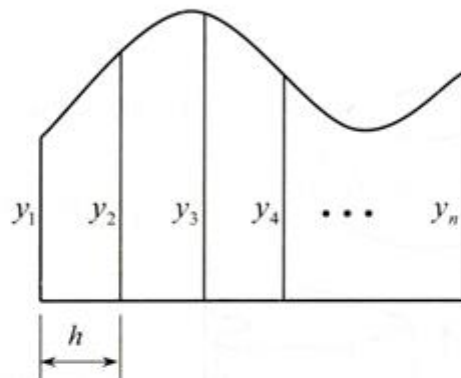

Riail
thraipéasóideach

$$A \approx \frac{h}{2} [y_1 + y_n + 2(y_2 + y_3 + y_4 + \dots + y_{n-1})]$$

Trapezoidal rule

Riail Simpson
áit ar corruimhir n

$$A \approx \frac{h}{3} [y_1 + y_n + 2(y_3 + y_5 + \dots + y_{n-2}) + 4(y_2 + y_4 + \dots + y_{n-1})]$$

Simpson's rule
for odd n

$$\tan A = \frac{\sin A}{\cos A} \quad \cot A = \frac{\cos A}{\sin A}$$

$$\sec A = \frac{1}{\cos A} \quad \operatorname{cosec} A = \frac{1}{\sin A}$$

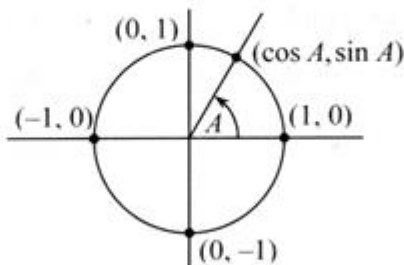

$$\cos^2 A + \sin^2 A = 1$$

$$\sec^2 A = 1 + \tan^2 A$$

$$\cos(-A) = \cos A$$

$$\sin(-A) = -\sin A$$

$$\tan(-A) = -\tan A$$

Nóta: Bíonn $\tan A$ agus $\sec A$ gan sainiú nuair $\cos A = 0$.
Bíonn $\cot A$ agus $\operatorname{cosec} A$ gan sainiú nuair $\sin A = 0$.

Note: $\tan A$ and $\sec A$ are not defined when $\cos A = 0$.
 $\cot A$ and $\operatorname{cosec} A$ are not defined when $\sin A = 0$.

A (céimeanna)	0°	90°	180°	270°	30°	45°	60°	A (degrees)
A (raidian)	0	$\frac{\pi}{2}$	π	$\frac{3\pi}{2}$	$\frac{\pi}{6}$	$\frac{\pi}{4}$	$\frac{\pi}{3}$	A (radians)
$\cos A$	1	0	-1	0	$\frac{\sqrt{3}}{2}$	$\frac{1}{\sqrt{2}}$	$\frac{1}{2}$	$\cos A$
$\sin A$	0	1	0	-1	$\frac{1}{2}$	$\frac{1}{\sqrt{2}}$	$\frac{\sqrt{3}}{2}$	$\sin A$
$\tan A$	0	-	0	-	$\frac{1}{\sqrt{3}}$	1	$\sqrt{3}$	$\tan A$

$$1 \text{ rad.} \approx 57.296^\circ$$

$$1^\circ \approx 0.01745 \text{ rad.}$$



Foirmlí uillinneacha comhshuite

$$\cos(A + B) = \cos A \cos B - \sin A \sin B$$

$$\sin(A + B) = \sin A \cos B + \cos A \sin B$$

$$\tan(A + B) = \frac{\tan A + \tan B}{1 - \tan A \tan B}$$

Compound angle formulae

$$\cos(A - B) = \cos A \cos B + \sin A \sin B$$

$$\sin(A - B) = \sin A \cos B - \cos A \sin B$$

$$\tan(A - B) = \frac{\tan A - \tan B}{1 + \tan A \tan B}$$

Foirmlí uillinneacha dúbailte

$$\cos 2A = \cos^2 A - \sin^2 A$$

$$\sin 2A = 2 \sin A \cos A$$

$$\cos^2 A = \frac{1}{2}(1 + \cos 2A)$$

$$\sin^2 A = \frac{1}{2}(1 - \cos 2A)$$

Double angle formulae

$$\tan 2A = \frac{2 \tan A}{1 - \tan^2 A}$$

$$\cos 2A = \frac{1 - \tan^2 A}{1 + \tan^2 A}$$

$$\sin 2A = \frac{2 \tan A}{1 + \tan^2 A}$$



Iolraigh a thiontú ina suimeanna agus ina ndifríochtaí**Products to sums and differences**

$$2 \cos A \cos B = \cos(A + B) + \cos(A - B)$$

$$2 \sin A \cos B = \sin(A + B) + \sin(A - B)$$

$$2 \sin A \sin B = \cos(A - B) - \cos(A + B)$$

$$2 \cos A \sin B = \sin(A + B) - \sin(A - B)$$

Suimeanna agus difríochtaí a thiontú ina n-iolraigh**Sums and differences to products**

$$\cos A + \cos B = 2 \cos \frac{A+B}{2} \cos \frac{A-B}{2}$$

$$\cos A - \cos B = -2 \sin \frac{A+B}{2} \sin \frac{A-B}{2}$$

$$\sin A + \sin B = 2 \sin \frac{A+B}{2} \cos \frac{A-B}{2}$$

$$\sin A - \sin B = 2 \cos \frac{A+B}{2} \sin \frac{A-B}{2}$$

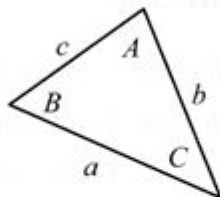

Triantánacht an triantáin**Trigonometry of the triangle**

achar

$$\frac{1}{2}ab \sin C$$

area

riail an tsínis

$$\frac{a}{\sin A} = \frac{b}{\sin B} = \frac{c}{\sin C}$$

sine rule

riail an chomhshinis

$$a^2 = b^2 + c^2 - 2bc \cos A$$

cosine rule

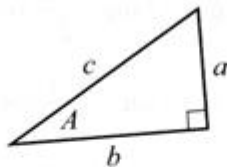
Triantán dronuilleach**Right-angled triangle**

$$\sin A = \frac{a}{c}$$

$$\cos A = \frac{b}{c}$$

$$\tan A = \frac{a}{b}$$

teoirim Phiotagaráis

$$c^2 = a^2 + b^2$$

Pythagoras' theorem



Nodaireacht

Notation

líne trí A agus B	AB	line through A and B
mírlíne ó A go B	$[AB]$	line segment from A to B
fad ó A go B	$ AB $	distance from A to B
veicteoir ó A go B	\overrightarrow{AB}	vector from A to B
veicteoir ón mbunphointe O go A	$\overrightarrow{OA} = \vec{a}$	vector from origin O to A

Oibríochtaí le veicteoirí

Vector operations

nuair a thugtar na haonadveicteoirí
ceartingearacha \vec{i} agus \vec{j} agus

given perpendicular unit vectors \vec{i} and \vec{j}
and $\vec{v}_1 = x_1\vec{i} + y_1\vec{j}$ and $\vec{v}_2 = x_2\vec{i} + y_2\vec{j}$

$$\vec{v}_1 = x_1\vec{i} + y_1\vec{j} \text{ agus } \vec{v}_2 = x_2\vec{i} + y_2\vec{j}$$

norm

$$|\vec{v}_1| = \sqrt{x_1^2 + y_1^2}$$

norm

iolrach scálach

$$\begin{aligned} \vec{v}_1 \cdot \vec{v}_2 &= x_1x_2 + y_1y_2 \\ &= |\vec{v}_1| |\vec{v}_2| \cos \theta \end{aligned}$$

scalar product

Líne

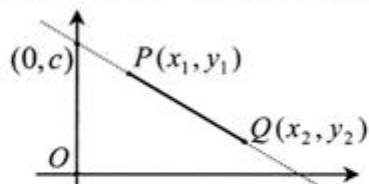

Line

fána PQ

$$m = \frac{y_2 - y_1}{x_2 - x_1}$$

slope of PQ fad $[PQ]$

$$|PQ| = \sqrt{(x_2 - x_1)^2 + (y_2 - y_1)^2}$$

length of $[PQ]$ lárphointe $[PQ]$

$$\left(\frac{x_1 + x_2}{2}, \frac{y_1 + y_2}{2} \right)$$

midpoint of $[PQ]$ cothromóid PQ

$$\begin{aligned} y - y_1 &= m(x - x_1) \\ y &= mx + c \end{aligned}$$

equation of PQ achar an triantáin OPQ

$$\frac{1}{2} |x_1 y_2 - x_2 y_1|$$

area of triangle OPQ pointe a roinneann $[PQ]$
sa chóimheas $a : b$

$$\left(\frac{bx_1 + ax_2}{b+a}, \frac{by_1 + ay_2}{b+a} \right)$$

point dividing $[PQ]$
in the ratio $a : b$ 

an fad ó (x_1, y_1) go dtí an líne
 $ax + by + c = 0$

$$\frac{|ax_1 + by_1 + c|}{\sqrt{a^2 + b^2}}$$

distance from (x_1, y_1) to the line
 $ax + by + c = 0$

uillinneacha idir dhá líne dar fánaí
 m_1 agus m_2

$$\tan \theta = \pm \frac{m_1 - m_2}{1 + m_1 m_2}$$

angles between two lines of
slopes m_1 and m_2

Ciorcal

Circle

nuair a thugtar an lárphointe
 (h, k) agus an ga r

given centre (h, k) and radius r

cothromóid

$$(x - h)^2 + (y - k)^2 = r^2$$

equation

tadhlaí ag (x_1, y_1)

$$(x - h)(x_1 - h) + (y - k)(y_1 - k) = r^2$$

tangent at (x_1, y_1)

nuair a thugtar an chothromóid
 $x^2 + y^2 + 2gx + 2fy + c = 0$

given equation $x^2 + y^2 + 2gx + 2fy + c = 0$

lárphointe

$$(-g, -f)$$

centre

ga

$$\sqrt{g^2 + f^2 - c}$$

radius

tadhlaí ag (x_1, y_1)

$$xx_1 + yy_1 + g(x + x_1) + f(y + y_1) + c = 0$$

tangent at (x_1, y_1)



fréamhacha na cothromóide cearnaí
 $ax^2 + bx + c = 0$

$$x = \frac{-b \pm \sqrt{b^2 - 4ac}}{2a}$$

roots of the quadratic equation
 $ax^2 + bx + c = 0$

inbhéarta na maitrise $A = \begin{pmatrix} a & b \\ c & d \end{pmatrix}$ leis an
 deitármanant $\det(A) = ad - bc \neq 0$

$$\frac{1}{\det(A)} \begin{pmatrix} d & -b \\ -c & a \end{pmatrix}$$

inverse of the matrix $A = \begin{pmatrix} a & b \\ c & d \end{pmatrix}$ with
 determinant $\det(A) = ad - bc \neq 0$

Teoirim de Moivre

$$[r(\cos \theta + i \sin \theta)]^n = r^n (\cos n\theta + i \sin n\theta) = r^n e^{in\theta}$$

De Moivre's theorem**An Teoirim dhéthéarmach**

$$(x + y)^n = \sum_{r=0}^n \binom{n}{r} x^{n-r} y^r = \binom{n}{0} x^n + \binom{n}{1} x^{n-1} y + \binom{n}{2} x^{n-2} y^2 + \cdots + \binom{n}{r} x^{n-r} y^r + \cdots + \binom{n}{n} y^n$$

Binomial theorem

comhéifeachtaí déthéarmacha

$$\binom{n}{r} = {}^n C_r = C(n, r) = \frac{n!}{r!(n-r)!}$$

binomial coefficients

$$a^p a^q = a^{p+q}$$

$$\frac{a^p}{a^q} = a^{p-q}$$

$$(a^p)^q = a^{pq}$$

$$a^0 = 1$$

$$a^{-p} = \frac{1}{a^p}$$

$$a^{\frac{1}{q}} = \sqrt[q]{a}$$

$$a^{\frac{p}{q}} = \sqrt[q]{a^p} = (\sqrt[q]{a})^p$$

$$(ab)^p = a^p b^p$$

$$\left(\frac{a}{b}\right)^p = \frac{a^p}{b^p}$$

$$\log_a(xy) = \log_a x + \log_a y$$

$$\log_a\left(\frac{x}{y}\right) = \log_a x - \log_a y$$

$$\log_a(x^q) = q \log_a x$$

$$\log_a 1 = 0$$

$$\log_a\left(\frac{1}{x}\right) = -\log_a x$$

$$a^x = y \Leftrightarrow \log_a y = x$$

$$\log_a(a^x) = x$$

$$a^{\log_a x} = x$$

$$\log_b x = \frac{\log_a x}{\log_a b}$$

Seichimh agus sraitheanna

Sequences and series

Is é T_n an n ú téarma iontu seo, agus is é S_n suim na chéad n téarma.

In the following, T_n is the n^{th} term, and S_n is the sum of the first n terms.

Seicheamh combhbheise nó sraith chombhbheise

nuair:

is é a an chéad téarma, agus

is é d an chombhbheis

$$T_n = a + (n-1)d$$

$$S_n = \frac{n}{2}[2a + (n-1)d]$$

Arithmetic sequence or series

where:

a is the first term

d is the common difference

Seicheamh iolraíoch nó sraith iolraíoch

nuair:

is é a an chéad téarma, agus

is é r an comhiolraitheoir

$$T_n = ar^{n-1}$$

$$S_n = \frac{a(1-r^n)}{1-r}$$

$$S_\infty = \frac{a}{1-r}$$

Geometric sequence or series

where:

a is the first term

r is the common ratio

nuair a thugtar $|r| < 1$

given $|r| < 1$

Siombailí na dtacar

idirmhír	\cap
aontas	\cup
difríocht (lúide)	\setminus
difríocht shiméadrach	Δ
fothacar de	\subset
ball de	\in
tacar nialasach	\emptyset

Set symbols

intersection
union
difference (less)
symmetric difference
is a subset of
is an element of
null set

Tacair uimhreacha

uimhreacha aiceanta

$$\mathbb{N} = \{1, 2, 3, 4, 5, 6, \dots\}$$

natural numbers

slánuimhreacha

$$\mathbb{Z} = \{\dots -3, -2, -1, 0, 1, 2, 3, \dots\}$$

integers

uimhreacha cóimheasta

$$\mathbb{Q} = \left\{ \frac{p}{q} \mid p \in \mathbb{Z}, q \in \mathbb{Z}, q \neq 0 \right\}$$

rational numbers

réaduimhreacha

$$\mathbb{R}$$

real numbers

uimhreacha coimpléascacha

$$\mathbb{C} = \{a + bi \mid a \in \mathbb{R}, b \in \mathbb{R}, i^2 = -1\}$$

complex numbers



Siombailí loighece

AND

OR

NOT

NAND

NOR

tugann le fios

coibhéiseach le

do gach

tá...ann

a thugann

dá réir sin

 \wedge \vee \neg \uparrow \downarrow \Rightarrow \Leftrightarrow \forall \exists \vdash \therefore **Logic symbols**

AND

OR

NOT

NAND

NOR

implies

is equivalent to

for all

there exists

yields, (infer)

therefore

Dlíthe de Morgan

$$\neg(A \wedge B) \Leftrightarrow (\neg A) \vee (\neg B)$$

$$\neg(A \vee B) \Leftrightarrow (\neg A) \wedge (\neg B)$$

De Morgan's laws**Séanadh agus cainníochtóirí**

$$\neg((\forall x)A(x)) \Leftrightarrow (\exists x)(\neg A(x))$$

$$\neg((\exists x)A(x)) \Leftrightarrow (\forall x)(\neg A(x))$$

Negation and quantifiers

Díorthaigh

Derivatives

$f(x)$	$f'(x)$
x^n	nx^{n-1}
$\ln x$	$\frac{1}{x}$
e^x	e^x
e^{ax}	ae^{ax}
a^x	$a^x \ln a$
$\cos x$	$-\sin x$
$\sin x$	$\cos x$
$\tan x$	$\sec^2 x$
$\cos^{-1} \frac{x}{a}$	$-\frac{1}{\sqrt{a^2 - x^2}}$
$\sin^{-1} \frac{x}{a}$	$\frac{1}{\sqrt{a^2 - x^2}}$
$\tan^{-1} \frac{x}{a}$	$\frac{a}{a^2 + x^2}$

Riail an toraidh

$$y = uv$$

$$\Rightarrow \frac{dy}{dx} = u \frac{dv}{dx} + v \frac{du}{dx}$$

Product rule

Riail an lín

$$y = \frac{u}{v}$$

$$\Rightarrow \frac{dy}{dx} = \frac{v \frac{du}{dx} - u \frac{dv}{dx}}{v^2}$$

Quotient rule

Cuingriail

$$f(x) = u(v(x))$$

$$\Rightarrow f'(x) = \frac{du}{dv} \frac{dv}{dx}$$

Chain rule



Suimeálaithe

Tá tairisigh na suimeála fágtha ar lár.

$f(x)$	$\int f(x)dx$
$x^n \quad (n \neq -1)$	$\frac{x^{n+1}}{n+1}$
$\frac{1}{x}$	$\ln x $
e^x	e^x
e^{ax}	$\frac{1}{a}e^{ax}$
a^x	$\frac{a^x}{\ln a}$
$\cos x$	$\sin x$
$\sin x$	$-\cos x$
$\tan x$	$\ln \sec x $

$f(x)$	$\int f(x)dx$
$\cos^2 x$	$\frac{1}{2}\left[x + \frac{1}{2}\sin 2x\right]$
$\sin^2 x$	$\frac{1}{2}\left[x - \frac{1}{2}\sin 2x\right]$
$\frac{1}{\sqrt{a^2 - x^2}}$	$\sin^{-1} \frac{x}{a}$
$\frac{1}{x^2 + a^2}$	$\frac{1}{a} \tan^{-1} \frac{x}{a}$

**Suimeáil
na míreanna**

$$\int u dv = uv - \int v du$$

Integration by parts

Integrals

Constants of integration omitted.

$f(x)$	$\int f(x)dx$
$\frac{1}{x\sqrt{x^2 - a^2}}$	$\frac{1}{a} \sec^{-1} \frac{x}{a}$
$\frac{1}{\sqrt{x^2 + a^2}}$	$\ln \left \frac{x + \sqrt{x^2 + a^2}}{a} \right $
$\frac{1}{a^2 - x^2}$	$\frac{1}{2a} \ln \left \frac{a+x}{a-x} \right $
$\frac{1}{\sqrt{x^2 - a^2}}$	$\ln \left \frac{x + \sqrt{x^2 - a^2}}{a} \right $



Atriall Newton-Raphson

$$x_{n+1} = x_n - \frac{f(x_n)}{f'(x_n)}$$

Newton-Raphson iteration

Sraith Taylor agus a mar lárphointe

Taylor series with centre a

$$f(a+x) = f(a) + f'(a)x + \frac{f''(a)}{2!}x^2 + \dots + \frac{f^{(r)}(a)}{r!}x^r + \dots$$

Sraith Maclaurin

Maclaurin series

$$f(x) = f(0) + f'(0)x + \frac{f''(0)}{2!}x^2 + \dots + \frac{f^{(r)}(0)}{r!}x^r + \dots$$

Toirt solaid imrothlaithe timpeall ar an x -ais

Volume of solid of revolution about x -axis

$$V = \int_{x=a}^{x=b} \pi y^2 dx$$



Leaisteachas

Iontu seo a leanas,
P = praghas, *Q* = cainníocht, *Y* = ioncam,
 tagraíonn foscruit 1 agus 2 don am
 roimh an athrú agus ina dhiaidh,
 agus seasann *A* agus *B* do na hearraí *A* agus *B*.

Elasticity

In the following,
P = price, *Q* = quantity, *Y* = income,
 subscripts 1 and 2 refer to
 before and after change,
A and *B* refer to goods *A* and *B*.

praghasleaisteachas an éilimh	$\frac{\Delta Q}{\Delta P} \times \frac{P_1 + P_2}{Q_1 + Q_2}$	price elasticity of demand
ioncamleaisteachas an éilimh	$\frac{\Delta Q}{\Delta Y} \times \frac{Y_1 + Y_2}{Q_1 + Q_2}$	income elasticity of demand
trasleaisteachas an éilimh	$\frac{\Delta Q_A}{\Delta P_B} \times \frac{P_{1,B} + P_{2,B}}{Q_{1,A} + Q_{2,A}}$	cross price elasticity of demand
praghasleaisteachas an tsoláthair	$\frac{\Delta Q}{\Delta P} \times \frac{P_1 + P_2}{Q_1 + Q_2}$	price elasticity of supply



Cothromóid OTI

Y = olltáirgeacht intíre

C = caiteachas ar thomhaltas

I = caiteachas ar infheistíocht

G = ceannacháin rialtais

$(X - M)$ = glanluach easpórtálacha

$$Y = C + I + G + (X - M)$$

GDP equation

Y = gross domestic product

C = consumption expenditure

I = investment expenditure

G = government purchases

$(X - M)$ = net exports

Iolraitheoirí

Iontu seo a leanas,

MPC = claonadh imeallach chun tomhaltais

MPS = claonadh imeallach chun coigilte

MPM = claonadh imeallach chun iompórtála

MPT = claonadh imeallach chun cáin a íoc

Nóta: $MPS = 1 - MPC$

geilleagar iata gan earnáil rialtais

$$\frac{1}{MPS}$$

closed economy with no government sector

geilleagar oscailte gan earnáil rialtais

$$\frac{1}{MPS + MPM}$$

open economy with no government sector

geilleagar oscailte le hearnáil rialtais

$$\frac{1}{MPS + MPM + MPT}$$

open economy with government sector

Multipliers

In the following,

MPC = marginal propensity to consume

MPS = marginal propensity to save

MPM = marginal propensity to import

MPT = marginal propensity to pay tax

Note: $MPS = 1 - MPC$



Matamaitic an airgeadais

Financial mathematics

Iontu seo a leanas, is é t an fad ama ina bhlianta agus is é i an ráta bliantúil úis, dímheasa nó fáis, agus é sloinnte mar dheachúil nó mar chodán (ionas go seasann $i = 0.08$ do ráta 8%, mar shampla)*.

In all of the following, t is the time in years and i is annual rate of interest, depreciation or growth, expressed as a decimal or fraction (so that, for example, $i = 0.08$ represents a rate of 8%)*.

Ús iolraithe

F = luach deiridh, P = príomhshuim

$$F = P(1 + i)^t$$

Compound interest

F = final value, P = principal

Luach láithreach

P = luach láithreach, F = luach deiridh

$$P = \frac{F}{(1 + i)^t}$$

Present value

P = present value, F = final value

Dímheas

– modh an chomhardaithe laghdaithe

F = luach déanach, P = luach tosaigh

$$F = P(1 - i)^t$$

Depreciation

– reducing balance method

F = later value, P = initial value

Dímheas

– an modh dronlíneach

A = méid an dímheasa bhliantúil

P = luach tosaigh, S = dramhluach

t = saolré eacnamaíoch fhónta

$$A = \frac{P - S}{t}$$

Depreciation

– straight line method

A = annual depreciation amount

P = initial value, S = scrap value

t = useful economic life

*Bíonn feidhm ag na foirmlí sin freisin nuair a bhítear ag athiúlú i gceann eatraimh chothroma seachas blianta. Sa chás sin, déantar t a thomhas sa tréimhse chuí ama, agus is é i an ráta don tréimhse.

*The formulae also apply when compounding at equal intervals other than years. In such cases, t is measured in the relevant periods of time, and i is the period rate.



Amúchadh – morgáistí agus iasachtaí
(aisíocaíochtaí cothroma i gceann eatraimh
chothroma)

A = méid na haisíocaíochta bliantúla

P = príomhshuim

$$A = P \frac{i(1+i)^t}{(1+i)^t - 1}$$

Amortisation – mortgages and loans
(equal repayments at equal intervals)

A = annual repayment amount

P = principal

Ráta céatadánach bliantúil (RCB)
– foirmle reachtúil

Is ionann an RCB agus luach i (agus é sloinnte ina chéatadán) nuair is ionann suim luachanna reatha na n -airleacan uile agus suim luachanna reatha na n -aisíocaíochtaí uile. Is é sin, luach i áit a bhfuil:

$$\sum_{k=1}^N \frac{A_k}{(1+i)^{T_k}} = \sum_{j=1}^n \frac{R_j}{(1+i)^{t_j}}$$

nuair:

is é N líon na n -airleacan

is é n líon na n -aisíocaíochtaí

is é A_k méid an airleacain k

is é R_j méid na haisíocaíochta j

is é T_k an fad ama ina bhlianta go dtí airleacan k

is é t_j an fad ama ina bhlianta go dtí aisíocaíocht j

Annual percentage rate (APR)
– statutory formula

The APR is the value of i (expressed as a percentage) for which the sum of the present values of all advances is equal to the sum of the present values of all repayments. That is, the value of i for which:

where:

N is the number of advances

n is the number of repayments

A_k is the amount of advance k

R_j is the amount of repayment j

T_k is the time in years to advance k

t_j is the time in years to repayment j

**Tréimhse eile iolraithe a thiontú
ina ráta bliantúil**

$$i = \left(1 + \frac{r}{m}\right)^m - 1$$

nuair
is é i an ráta bliantúil iarbhír (mar dheachúil)
is é r an ráta bliantúil ainmniúil (mar dheachúil)
is é m líon na dtréimhsi athiolraithe in aon bhliain
amháin

Athiolrú leanúnach

$$F = Pe^{rt}$$
$$i = e^r - 1$$
$$r = \log_e(1 + i)$$

nuair
is é F an luach deiridh
is é P an príomhshuim
is é r an ráta bliantúil ainmniúil
is é i an ráta bliantúil iarbhír

**Converting to annual rate from other
compounding period**

where
 i is the actual annual rate (as a decimal)
 r is the nominal annual rate (as a decimal)
 m is the number of compounding periods in one year

Continuous compounding

where
 F is the final value
 P is the principal
 r is the nominal annual rate
 i is the actual annual rate



Staitisticí agus dóchúlacht

An Meán	33
An Diall caighdeánach	33
Dáiltí dóchúlachta	33
Sampláil	34
Tástáil hipitéisí	35
Dóchúlachtaí don dáileadh normalach coughteánach	36
Dáileadh chí-chearnaithe	38
<i>t</i> -dháileadh Student	40
Mearthástáil Tukey (foirm achomair)	42
Comhéifeacht Spearman do chomhchoibhneas na rang-ord	42
U-thástáil Mann-Whitney	43

Statistics and probability

Mean
Standard deviation
Probability distributions
Sampling
Hypothesis testing
Probabilities for the standard normal distribution
Chi-squared distribution
Student's <i>t</i> -distribution
Tukey quick test (compact form)
Spearman's rank-order correlation coefficient
Mann-Whitney U-test

An Meán

Mean

ó liosta de n uimhir	$\mu = \frac{\sum x}{n}$	from list of n numbers
ó thábla minicíochta	$\mu = \frac{\sum fx}{\sum f}$	from frequency table

An Diall caighdeánach

Standard deviation

ó liosta de n uimhir	$\sigma = \sqrt{\frac{\sum (x - \mu)^2}{n}}$	from list of n numbers
ó thábla minicíochta	$\sigma = \sqrt{\frac{\sum f(x - \mu)^2}{\sum f}}$	from frequency table

Dáiltí dóchúlachta

Probability distributions

an dáileadh déthéarmach	$P(X = r) = \binom{n}{r} p^r q^{n-r}$ $r = 0 \dots n$	binomial distribution
an meán	$\mu = np$	mean
an diall caighdeánach	$\sigma = \sqrt{npq}$	standard deviation



dáileadh Poisson	$P(X = r) = e^{-\lambda} \frac{\lambda^r}{r!}$ $r = 0, 1, 2, \dots$	Poisson distribution
an meán an diall caighdeánach	$\mu = \lambda$ $\sigma = \sqrt{\lambda}$	mean standard deviation
an dáileadh normalach (dáileadh Gauss)	$f(X) = \frac{1}{\sigma\sqrt{2\pi}} e^{-\frac{(X-\mu)^2}{2\sigma^2}}$	normal (Gaussian) distribution
an dáileadh normalach caighdeánach	$f(Z) = \frac{1}{\sqrt{2\pi}} e^{-\frac{1}{2}Z^2}$	standard normal distribution
foirmle an chaighdeánaithe	$z = \frac{x - \mu}{\sigma}$	standardising formula
Sampláil		Sampling
meastachán ar dhiall caighdeánach an daonra ó sampla	$s = \sqrt{\frac{\sum(x - \bar{x})^2}{n-1}}$	estimate of population standard deviation from sample
earráid chaighdeánach an mheáin	$\sigma_{\bar{x}} = \frac{\sigma}{\sqrt{n}}$	standard error of the mean
earráid chaighdeánach na comhréire	$\sigma_{\hat{p}} = \sqrt{\frac{p(1-p)}{n}}$	standard error of the proportion



Tástáil hipitéisí	Hypothesis testing
z-thástáil aon sampla	$z = \frac{\bar{x} - \mu}{\left(\frac{\sigma}{\sqrt{n}}\right)}$ one-sample z-test
t-thástáil aon sampla	$t = \frac{\bar{x} - \mu}{\left(\frac{s}{\sqrt{n}}\right)} ; \quad \nu = n - 1$ one-sample t-test
z-thástáil dhá shampla	$z = \frac{\bar{x}_1 - \bar{x}_2}{\sqrt{\frac{\sigma_1^2}{n_1} + \frac{\sigma_2^2}{n_2}}}$ two-sample z-test
t-thástáil dhá shampla (comhthiomsaithe)	$t = \frac{\bar{x}_1 - \bar{x}_2}{s \sqrt{\frac{1}{n_1} + \frac{1}{n_2}}} ; \quad s^2 = \frac{(n_1 - 1)s_1^2 + (n_2 - 1)s_2^2}{n_1 + n_2 - 2} ; \quad \nu = n_1 + n_2 - 2$ two-sample t-test (pooled)
tástáil χ^2 ar fheabhas na hoiriúnachta k catagóir, m paraiméadar mheasta	$\chi^2 = \sum_{i=1}^k \frac{(o_i - e_i)^2}{e_i} ; \quad \nu = k - 1 - m$ χ^2 goodness-of-fit test k categories, m estimated parameters
suntasacht chomhéifeacht an chomhchoibhnis (Pearson)	$t = \frac{r\sqrt{n-2}}{\sqrt{1-r^2}} ; \quad \nu = n - 2$ significance of correlation coefficient (Pearson)



Dóchúlachtaí don dáileadh normalach caighdeánach

I gcás z a thugtar, faightear ón tábla

$$P(Z \leq z) = \frac{1}{\sqrt{2\pi}} \int_{-\infty}^z e^{-\frac{1}{2}t^2} dt$$

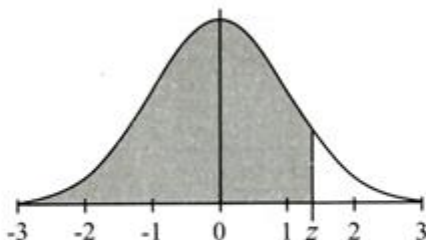

Probabilities for the standard normal distribution

For a given z , the table gives

$$P(Z \leq z) = \frac{1}{\sqrt{2\pi}} \int_{-\infty}^z e^{-\frac{1}{2}t^2} dt$$

z	0.00	0.01	0.02	0.03	0.04	0.05	0.06	0.07	0.08	0.09
0.0	0.5000	.5040	.5080	.5120	.5160	.5199	.5239	.5279	.5319	.5359
0.1	0.5398	.5438	.5478	.5517	.5557	.5596	.5636	.5675	.5714	.5753
0.2	0.5793	.5832	.5871	.5910	.5948	.5987	.6026	.6064	.6103	.6141
0.3	0.6179	.6217	.6255	.6293	.6331	.6368	.6406	.6443	.6480	.6517
0.4	0.6554	.6591	.6628	.6664	.6700	.6736	.6772	.6808	.6844	.6879
0.5	0.6915	.6950	.6985	.7019	.7054	.7088	.7123	.7157	.7190	.7224
0.6	0.7257	.7291	.7324	.7357	.7389	.7422	.7454	.7486	.7517	.7549
0.7	0.7580	.7611	.7642	.7673	.7704	.7734	.7764	.7794	.7823	.7852
0.8	0.7881	.7910	.7939	.7967	.7995	.8023	.8051	.8078	.8106	.8133
0.9	0.8159	.8186	.8212	.8238	.8264	.8289	.8315	.8340	.8365	.8389
1.0	0.8413	.8438	.8461	.8485	.8508	.8531	.8554	.8577	.8599	.8621



an dáileadh normalach (ar lean)

normal distribution (continued)

<i>z</i>	0.00	0.01	0.02	0.03	0.04	0.05	0.06	0.07	0.08	0.09
1.1	0.8643	.8665	.8686	.8708	.8729	.8749	.8770	.8790	.8810	.8830
1.2	0.8849	.8869	.8888	.8907	.8925	.8944	.8962	.8980	.8997	.9015
1.3	0.9032	.9049	.9066	.9082	.9099	.9115	.9131	.9147	.9162	.9177
1.4	0.9192	.9207	.9222	.9236	.9251	.9265	.9279	.9292	.9306	.9319
1.5	0.9332	.9345	.9357	.9370	.9382	.9394	.9406	.9418	.9429	.9441
1.6	0.9452	.9463	.9474	.9484	.9495	.9505	.9515	.9525	.9535	.9545
1.7	0.9554	.9564	.9573	.9582	.9591	.9599	.9608	.9616	.9625	.9633
1.8	0.9641	.9649	.9656	.9664	.9671	.9678	.9686	.9693	.9699	.9706
1.9	0.9713	.9719	.9726	.9732	.9738	.9744	.9750	.9756	.9761	.9767
2.0	0.9772	.9778	.9783	.9788	.9793	.9798	.9803	.9808	.9812	.9817
2.1	0.9821	.9826	.9830	.9834	.9838	.9842	.9846	.9850	.9854	.9857
2.2	0.9861	.9864	.9868	.9871	.9875	.9878	.9881	.9884	.9887	.9890
2.3	0.9893	.9896	.9898	.9901	.9904	.9906	.9909	.9911	.9913	.9916
2.4	0.9918	.9920	.9922	.9925	.9927	.9929	.9931	.9932	.9934	.9936
2.5	0.9938	.9940	.9941	.9943	.9945	.9946	.9948	.9949	.9951	.9952
2.6	0.9953	.9955	.9956	.9957	.9959	.9960	.9961	.9962	.9963	.9964
2.7	0.9965	.9966	.9967	.9968	.9969	.9970	.9971	.9972	.9973	.9974
2.8	0.9974	.9975	.9976	.9977	.9977	.9978	.9979	.9979	.9980	.9981
2.9	0.9981	.9982	.9982	.9983	.9984	.9984	.9985	.9985	.9986	.9986
3.0	0.9987	.9987	.9987	.9988	.9988	.9989	.9989	.9989	.9990	.9990



Dáileadh chí-chearnaithe

luachanna criticiúla tástála aonfhoirení

Nuair a thugtar A , faightear ón tábla an luach ar k mar a bhfuil $P(X > k) = A$, áit a leanann X dáileadh chí-chearnaithe a bhfuil v céim saoirse aige.

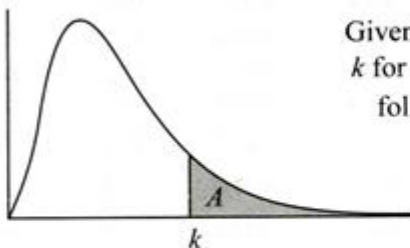

Chi-squared distribution

one-tailed critical values

Given A , the table gives the value of k for which $P(X > k) = A$, where X follows a chi-squared distribution with v degrees of freedom.

$v \backslash A$	0.995	0.99	0.975	0.95	0.05	0.025	0.01	0.005
1	0.0000	0.0002	0.0010	0.0039	3.8415	5.0239	6.6349	7.8794
2	0.0100	0.0201	0.0506	0.1026	5.9915	7.3778	9.2103	10.597
3	0.0717	0.1148	0.2158	0.3518	7.8147	9.3484	11.345	12.838
4	0.2070	0.2971	0.4844	0.7107	9.4877	11.143	13.277	14.860
5	0.4117	0.5543	0.8312	1.1455	11.070	12.833	15.086	16.750
6	0.6757	0.8721	1.2373	1.6354	12.592	14.449	16.812	18.548
7	0.9893	1.2390	1.6899	2.1673	14.067	16.013	18.475	20.278
8	1.3444	1.6465	2.1797	2.7326	15.507	17.535	20.090	21.955
9	1.7349	2.0879	2.7004	3.3251	16.919	19.023	21.666	23.589
10	2.1559	2.5582	3.2470	3.9403	18.307	20.483	23.209	25.188
11	2.6032	3.0535	3.8157	4.5748	19.675	21.920	24.725	26.757
12	3.0738	3.5706	4.4038	5.2260	21.026	23.337	26.217	28.300
13	3.5650	4.1069	5.0088	5.8919	22.362	24.736	27.688	29.819
14	4.0747	4.6604	5.6287	6.5706	23.685	26.119	29.141	31.319

dáileadh chí-chearnaithe (ar lean)

chi-squared distribution (continued)

v \ A	0.995	0.99	0.975	0.95	0.05	0.025	0.01	0.005
15	4.6009	5.2293	6.2621	7.2609	24.996	27.488	30.578	32.801
16	5.1422	5.8122	6.9077	7.9616	26.296	28.845	32.000	34.267
17	5.6972	6.4078	7.5642	8.6718	27.587	30.191	33.409	35.718
18	6.2648	7.0149	8.2307	9.3905	28.869	31.526	34.805	37.156
19	6.8440	7.6327	8.9065	10.117	30.144	32.852	36.191	38.582
20	7.4338	8.2604	9.5908	10.851	31.410	34.170	37.566	39.997
21	8.0337	8.8972	10.283	11.591	32.671	35.479	38.932	41.401
22	8.6427	9.5425	10.982	12.338	33.924	36.781	40.289	42.796
23	9.2604	10.196	11.689	13.091	35.172	38.076	41.638	44.181
24	9.8862	10.856	12.401	13.848	36.415	39.364	42.980	45.559
25	10.520	11.524	13.120	14.611	37.652	40.646	44.314	46.928
26	11.160	12.198	13.844	15.379	38.885	41.923	45.642	48.290
27	11.808	12.879	14.573	16.151	40.113	43.195	46.963	49.645
28	12.461	13.565	15.308	16.928	41.337	44.461	48.278	50.993
29	13.121	14.256	16.047	17.708	42.557	45.722	49.588	52.336
30	13.787	14.953	16.791	18.493	43.773	46.979	50.892	53.672
40	20.707	22.164	24.433	26.509	55.758	59.342	63.691	66.766
50	27.991	29.707	32.357	34.764	67.505	71.420	76.154	79.490
60	35.534	37.485	40.482	43.188	79.082	83.298	88.379	91.952
70	43.275	45.442	48.758	51.739	90.531	95.023	100.43	104.21
80	51.172	53.540	57.153	60.391	101.88	106.63	112.33	116.32
90	59.196	61.754	65.647	69.126	113.15	118.14	124.12	128.30
100	67.328	70.065	74.222	77.929	124.34	129.56	135.81	140.17



**Clár Staitisticí /
Statistics Contents**

Clár / Contents



***t*-dháileadh Student**

luachanna criticiúla tástála aonfhoircní

Nuair a thugtar A , faightear ón tábla an luach

ar k mar a bhfuil $P(T > k) = A$,

áit a leanann T , *t*-dháileadh a bhfuil v céim saoirse aige.

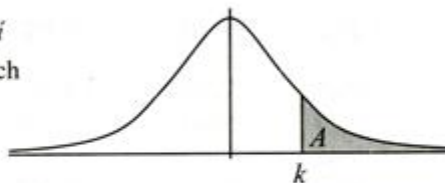

Student's *t*-distribution

one-tailed critical values

Given A , the table gives the value of k for which $P(T > k) = A$, where T follows a *t*-distribution with v degrees of freedom.

$v \backslash A$	0.1	0.05	0.025	0.01	0.005	0.001	0.0005	0.0001	0.00005
1	3.078	6.314	12.71	31.82	63.66	318.3	636.6	3183	6366
2	1.886	2.920	4.303	6.965	9.925	22.33	31.60	70.70	99.99
3	1.638	2.353	3.182	4.541	5.841	10.21	12.92	22.20	28.00
4	1.533	2.132	2.776	3.747	4.604	7.173	8.610	13.03	15.54
5	1.476	2.015	2.571	3.365	4.032	5.893	6.869	9.678	11.18
6	1.440	1.943	2.447	3.143	3.707	5.208	5.959	8.025	9.082
7	1.415	1.895	2.365	2.998	3.499	4.785	5.408	7.063	7.885
8	1.397	1.860	2.306	2.896	3.355	4.501	5.041	6.442	7.120
9	1.383	1.833	2.262	2.821	3.250	4.297	4.781	6.010	6.594
10	1.372	1.812	2.228	2.764	3.169	4.144	4.587	5.694	6.211
11	1.363	1.796	2.201	2.718	3.106	4.025	4.437	5.453	5.921
12	1.356	1.782	2.179	2.681	3.055	3.930	4.318	5.263	5.694
13	1.350	1.771	2.160	2.650	3.012	3.852	4.221	5.111	5.513
14	1.345	1.761	2.145	2.624	2.977	3.787	4.140	4.985	5.363

t-dháileadh Student (ar lean)

Student's *t*-distribution (continued)

$\nu \backslash A$	0.1	0.05	0.025	0.01	0.005	0.001	0.0005	0.0001	0.00005
15	1.341	1.753	2.131	2.602	2.947	3.733	4.073	4.880	5.239
16	1.337	1.746	2.120	2.583	2.921	3.686	4.015	4.790	5.134
17	1.333	1.740	2.110	2.567	2.898	3.646	3.965	4.715	5.043
18	1.330	1.734	2.101	2.552	2.878	3.610	3.922	4.648	4.966
19	1.328	1.729	2.093	2.539	2.861	3.579	3.883	4.590	4.899
20	1.325	1.725	2.086	2.528	2.845	3.552	3.850	4.539	4.838
21	1.323	1.721	2.080	2.518	2.831	3.527	3.819	4.492	4.785
22	1.321	1.717	2.074	2.508	2.819	3.505	3.792	4.452	4.736
23	1.319	1.714	2.069	2.500	2.807	3.485	3.768	4.416	4.694
24	1.318	1.711	2.064	2.492	2.797	3.467	3.745	4.382	4.654
25	1.316	1.708	2.060	2.485	2.787	3.450	3.725	4.352	4.619
26	1.315	1.706	2.056	2.479	2.779	3.435	3.707	4.324	4.587
27	1.314	1.703	2.052	2.473	2.771	3.421	3.689	4.299	4.556
28	1.313	1.701	2.048	2.467	2.763	3.408	3.674	4.276	4.531
29	1.311	1.699	2.045	2.462	2.756	3.396	3.660	4.254	4.505
30	1.310	1.697	2.042	2.457	2.750	3.385	3.646	4.234	4.482
40	1.303	1.684	2.021	2.423	2.704	3.307	3.551	4.094	4.321
50	1.299	1.676	2.009	2.403	2.678	3.261	3.496	4.014	4.228
60	1.296	1.671	2.000	2.390	2.660	3.232	3.460	3.962	4.169
80	1.292	1.664	1.990	2.374	2.639	3.195	3.416	3.899	4.095
100	1.290	1.660	1.984	2.364	2.626	3.174	3.390	3.861	4.054
∞	1.282	1.645	1.960	2.326	2.576	3.090	3.290	3.719	3.891



Clár Staitisticí /
Statistics Contents

Clár / Contents



Mearthástáil Tukey (foirm achomair)**Tukey quick test (compact form)**

Leibhéal suntasachta	5%	1%	0.1%	Significance level
Luach criticiúil áireamh na bhfoirceann	7	10	13	Critical value of tail-count

**Comhéifeacht Spearman
do chomhchoibhneas na rang-ord**
luachanna criticiúla tástála aonfhoircní

n	5%	2.5%
5	0.900	1.000
6	0.829	0.886
7	0.714	0.786
8	0.643	0.738
9	0.600	0.700
10	0.564	0.648
11	0.536	0.618
12	0.503	0.587
13	0.484	0.560
14	0.464	0.538
15	0.446	0.521
16	0.429	0.503

n	5%	2.5%
17	0.414	0.488
18	0.401	0.472
19	0.391	0.460
20	0.380	0.447
21	0.370	0.436
22	0.361	0.425
23	0.353	0.416
24	0.344	0.407
25	0.337	0.398
26	0.331	0.390
27	0.324	0.383
28	0.318	0.375

**Spearman's rank-order
correlation coefficient**
one-tailed critical values

n	5%	2.5%
29	0.312	0.368
30	0.306	0.362
31	0.301	0.356
32	0.296	0.350
33	0.291	0.345
34	0.287	0.340
35	0.283	0.335
36	0.279	0.330
37	0.275	0.325
38	0.271	0.321
39	0.267	0.317
40	0.264	0.313

U-thástáil Mann-Whitney

luachanna criticiúla tástála déshoirenne ar 5%

Má fhaightear luach ar U atá níos lú ná an luach sa tábla nó cothrom leis, tá difríocht shuntasach i gceist.

Mann-Whitney U-test

two-tailed 5% critical values

A value of U less than or equal to the value in the table indicates a significant difference.

		n_1																		n_2
2	3	4	5	6	7	8	9	10	11	12	13	14	15	16	17	18	19	20		
-	-	-	-	-	-	0	0	0	0	1	1	1	1	1	2	2	2	2	2	2
	-	-	0	1	1	2	2	3	3	4	4	5	5	6	6	7	7	8	8	3
		0	1	2	3	4	4	5	6	7	8	9	10	11	11	12	13	14	14	4
			2	3	5	6	7	8	9	11	12	13	14	15	17	18	19	20	20	5
				5	6	8	10	11	13	14	16	17	19	21	22	24	25	27	27	6
					8	10	12	14	16	18	20	22	24	26	28	30	32	34	34	7
						13	15	17	19	22	24	26	29	31	34	36	38	41	41	8
							17	20	23	26	28	31	34	37	39	42	45	48	48	9
								23	26	29	33	36	39	42	45	48	52	55	55	10
									30	33	37	40	44	47	51	55	58	62	62	11
										37	41	45	49	53	57	61	65	69	69	12
											45	50	54	59	63	67	72	76	76	13
												55	59	64	67	74	78	83	83	14
													64	70	75	80	85	90	90	15
														75	81	86	92	98	98	16
															87	93	99	105	105	17
																99	106	112	112	18
																	113	119	119	19
																		127	127	20

$U = \min\{U_1, U_2\}$ áit a bhfuil where

$$U_1 = R_1 - \frac{n_1(n_1 + 1)}{2}, \quad U_2 = R_2 - \frac{n_2(n_2 + 1)}{2}$$



Na bunaonaid

Tá Córas Idirnáisiúnta na nAonad (*Système International d'Unités*) bunaithe ar sheacht mbunchainníocht a nglactar leis iad a bheith neamhspleách ar a chéile. Is iad seo a leanas na bunaonaid:

Base units

The International System of Units (*Système International d'Unités*) is founded on seven base quantities, which are assumed to be mutually independent. These base units are:

Bunchainníocht	Bunaonad SI	Siombail an aonaid Symbol for unit	SI base unit	Base quantity
fad (<i>l</i>)	méadar	m	metre	length (<i>l</i>)
mais (<i>m</i>)	cileagram	kg	kilogram	mass (<i>m</i>)
am (<i>t</i>)	soicind	s	second	time (<i>t</i>)
sruth leictreach (<i>I</i>)	aimpéar	A	ampere	electric current (<i>I</i>)
teocht (<i>T</i>)	ceilvin	K	kelvin	temperature (<i>T</i>)
méid substainte (<i>n</i>)	mól	mol	mole	amount of substance (<i>n</i>)
déine lonrachais (<i>I_v</i>)	caindéala	cd	candela	luminous intensity (<i>I_v</i>)

Aonaid dhíortha

Is é is aonad díortha ann aonad is féidir a shloinneadh i dtéarmaí na mbunaonad agus a dtugtar ainm uathúil air, e.g. niútan (N) = kg m s⁻².

Derived units

A derived unit is a unit which can be expressed in terms of base units and is given a unique name, e.g. newton (N) = kg m s⁻².



Réimíreanna

Baintear leas as réimíreanna chun iolraithe agus fo-iolraithe deachúlacha d'aonaid SI a dhéanamh. Is iad seo na réimíreanna coitianta:

Réimír	Fachtóir Factor	Siombail Symbol	Prefix
yota-, yotai-	10^{24}	Y	yotta
zeitea-, zeiti-	10^{21}	Z	zetta
eicsea-, eicsi-	10^{18}	E	exa
peitea-, peiti-	10^{15}	P	peta
teirea-, teiri-	10^{12}	T	tera
gigea-, gigi-	10^9	G	giga
meigea-, meigi-	10^6	M	mega
cilea-, cili-	10^3	k	kilo
heictea-, heicti-	10^2	h	hecto
deaca-, deacai-	10^1	da	deka

Cónasctar siombail réimíre le siombail bunaonaid chun siombail nua aonaid a dhéanamh, e.g. ciliméadar (km), micreashoicind (μ s).

Prefixes

Prefixes are used to form decimal multiples and submultiples of SI units. The common prefixes are:

Réimír	Fachtóir Factor	Siombail Symbol	Prefix
yochta-, yochtai-	10^{-24}	y	yocto
zeiptea-, zeipti-	10^{-21}	z	zepto
ata-, atai	10^{-18}	a	atto
feimtea-, feimti-	10^{-15}	f	femto
picea-, pici-	10^{-12}	p	pico
nana-, nanai-	10^{-9}	n	nano
micrea-, micri-	10^{-6}	μ	micro
millea-, milli-	10^{-3}	m	milli
ceintea-, ceinti-	10^{-2}	c	centi
deicea-, deici-	10^{-1}	d	deci

The symbol for a prefix is combined with the symbol for the base unit to form a new unit symbol, e.g. kilometre (km), microsecond (μ s).



Tairiseach	Siombail Symbol	Luach Value	Constant
mais alfa-cháithnin	m_α	$6.644\ 6565 \times 10^{-27}$ kg	alpha particle mass
tairiseach Avogadro	N_A	$6.022\ 1415 \times 10^{23}$ mol ⁻¹	Avogadro constant
tairiseach Boltzmann	k	$1.380\ 6505 \times 10^{-23}$ J K ⁻¹	Boltzmann constant
mais leictreoin	m_e	$9.109\ 3826 \times 10^{-31}$ kg	electron mass
leictreonvolta	eV	$1.602\ 176\ 53 \times 10^{-19}$ J	electron volt
lucht leictreonach	e	$1.602\ 176\ 53 \times 10^{-19}$ C	electronic charge
tairiseach Faraday	F	$96\ 485.3383$ C mol ⁻¹	Faraday constant
tairiseach na himtharraingthe	G	6.6742×10^{-11} m ³ kg ⁻¹ s ⁻²	gravitational constant
mais neodróin	m_n	$1.674\ 927\ 28 \times 10^{-27}$ kg	neutron mass



Tairiseach	Siombail Symbol	Luach Value	Constant
tréscailteacht an tsaorspáis	μ_0	$4\pi \times 10^{-7} \text{ H m}^{-1}$	permeability of free space
ceadaíocht an tsaorspáis	ϵ_0	$8.854\,187\,817 \times 10^{-12} \text{ F m}^{-1}$	permittivity of free space
tairiseach Planck	h	$6.626\,0693 \times 10^{-34} \text{ J s}$	Planck constant
mais phrótóin	m_p	$1.672\,621\,71 \times 10^{-27} \text{ kg}$	proton mass
cóimheas maise prótóin is leictreoin	$\frac{m_p}{m_e}$	1836.182 672 16	proton-electron mass ratio
luas an tsolais <i>in vacuo</i>	c_0	$2.997\,924\,58 \times 10^8 \text{ m s}^{-1}$	speed of light <i>in vacuo</i>
aonad maise adamhaí aontaithe	u	$1.660\,5402 \times 10^{-27} \text{ kg}$	unified atomic mass unit
tairiseach uilíoch gáis	R	$8.314\,472 \text{ J K}^{-1} \text{ mol}^{-1}$	universal gas constant



Aicme ainm	Siombail Symbol	Mais / Mass (i gcoibhneas le mais leictreoin) (relative to mass of electron)	Leath-ré Half-life	Class name
Leaptóin				
leictreon	e	1	<i>cobhsai</i> / stable	electron
neoidrionó	ν	4.305×10^{-6}	<i>cobhsai</i> / stable	neutrino
muón	$\mu^+ \mu^-$	206.9	1.52×10^{-6} s	muon
tó	$\tau^+ \tau^-$	3478	2.05×10^{-13} s	tau
muón-neoidrionó	ν_μ	0.3327	<i>cobhsai</i> / stable	muon neutrino
tó-neoidrionó	ν_τ	30.33	<i>cobhsai</i> / stable	tau neutrino
Méasóin				
pí-mhéasón	$\pi^+ \pi^-$	273	1.80×10^{-8} s	pi meson
	π^0	264	5.82×10^{-17} s	
K-mhéasón	$K^+ K^-$	967	8.58×10^{-9} s	K meson
	K^0	975	—	
Baróin				
prótón	p	1836	<i>cobhsai</i> / stable	proton
neodrón	n	1839	6.14×10^2 s	neutron
lambda	Λ^0	2183	1.82×10^{-10} s	lambda
sigme	Σ^+	2328	5.56×10^{-11} s	sigma
	Σ^-	2343	1.02×10^{-10} s	
	Σ^0	2334	5.13×10^{-20} s	
xí	Ξ^-	2586	1.14×10^{-10} s	xi
	Ξ^0	2573	2.01×10^{-10} s	
óimige	Ω^-	3272	$\sim 10^{-10}$ s	omega



cuarc	siombail symbol	lucht charge	quark
uaschuarc	u	$\frac{2}{3}$	up
cuarc aduain	s	$-\frac{1}{3}$	strange
barrchuarc	t	$\frac{2}{3}$	top
íoschuarc	d	$-\frac{1}{3}$	down
briochtchuarc	c	$\frac{2}{3}$	charmed
bunchuarc	b	$-\frac{1}{3}$	bottom



Meicnic

Gluaisne lineach faoi luasghéarú tairiseach	50
Gluaisne choibhneasta	50
Imbhuailtí	51
Gluaisne I gciorcal	51
Meáchanláir	52
Múimintí táimhe	53
Coirp rothlacha	54
Gluaisne armónach shimplí	54
Fuinneamh agus obair	55
Imtharraingt	56
Fórsaí agus ábhair	57

Mechanics

Linear motion with constant acceleration
Relative motion
Collisions
Motion in a circle
Centres of gravity
Moments of inertia
Rotating bodies
Simple harmonic motion
Energy and work
Gravitation
Forces and materials

Tugtar liosta aibíteach de na siombailí a úsáidtear sna foirmle seo a leanas agus an bhri atá leo sa comhthéacs cuí ar leathanach 65.

An alphabetical list of the symbols used in the following formulae and their meaning in the relevant context is given on page 65.

Meicnic		Mechanics
fórsa agus luasghéarú	$F = ma$	force and acceleration
Gluaisne líneach faoi luasghéarú tairiseach	$v = u + at$ $s = ut + \frac{1}{2}at^2$ $v^2 = u^2 + 2as$ $s = \left(\frac{u + v}{2}\right)t$	Linear motion with constant acceleration
Gluaisne choibhneasta		Relative motion
díláithriú coibhneasta	$\vec{s}_{BC} = \vec{s}_B - \vec{s}_C$	relative displacement
treoluas coibhneasta	$\vec{v}_{BC} = \vec{v}_B - \vec{v}_C$	relative velocity
luasghéarú coibhneasta	$\vec{a}_{BC} = \vec{a}_B - \vec{a}_C$	relative acceleration



Imbhualtí

móiminteam cáithnín

$$mv$$

dlí turgnamhach Newton

$$v_1 - v_2 = -e(u_1 - u_2)$$

imchoimeád an mhóimintim

$$m_1u_1 + m_2u_2 = m_1v_1 + m_2v_2$$

ríog

$$I = \int F dt = mv - mu$$

Collisions

momentum of a particle

Newton's experimental law

conservation of momentum

impulse

Gluaisne i gciorc

uillinn ina raidiain

$$\theta = \frac{s}{r}$$

treoluas uilleach

$$\omega = \frac{\theta}{t}$$

treoluas lineach agus uilleach

$$v = r\omega$$

luasghéarú láraimsitheach

$$a = r\omega^2 = \frac{v^2}{r}$$

fórsa láraimsitheach

$$F = mr\omega^2 = \frac{mv^2}{r}$$

Motion in a circle

angle in radians

angular velocity

linear and angular velocity

centripetal acceleration

centripetal force



Meáchanlár

leathsféar soladach, ga r ,
fad slí ó lárphointe an leathsféir
go dtí an meáchanlár

$$\frac{3}{8}r$$

sliogán leathsféarach, ga r ,
fad slí ó lárphointe an leathsféir
go dtí an meáchanlár

$$\frac{1}{2}r$$

dronchón ciorclach soladach, airde h ,
fad slí ó bhonn an chóin
go dtí an meáchanlár

$$\frac{1}{4}h$$

lann thriantánach

$\frac{1}{3}$ ón mbonn feadh na meánlíne



foirm chomhordanáideach

$$\left(\frac{x_1 + x_2 + x_3}{3}, \frac{y_1 + y_2 + y_3}{3} \right)$$

stua, ga r , stua-uillinn 2θ
fad slí ó lárphointe an chiorcail
go dtí meáchanlár an stua

$$\frac{r \sin \theta}{\theta}$$

teascóg diosca, ga r , stua-uillinn 2θ
fad slí ó lárphointe an chiorcail
go dtí meáchanlár na teascóige

$$\frac{2r \sin \theta}{3\theta}$$

Centres of gravity

solid hemisphere, radius r
distance from centre of hemisphere
to centre of gravity

hemispherical shell, radius r
distance from centre of hemisphere
to centre of gravity

solid right circular cone, height h
distance from base of cone
to centre of gravity

triangular lamina

$\frac{1}{3}$ from base along median

co-ordinate form

arc, radius r , arc-angle 2θ
distance from centre of circle
to centre of gravity of arc

sector of disc, radius r , arc-angle 2θ
distance from centre of circle
to centre of gravity of sector

Móimintí táimhe**Moments of inertia**

slat aonfhoirmeach, fad $2l$ timpeall aise trí lárphointe ingearach leis an tslat	$\frac{1}{3} ml^2$	uniform rod, length $2l$ about axis through centre perpendicular to rod
timpeall aise ag foirceann amháin ingearach leis an tslat	$\frac{4}{3} ml^2$	about axis at one end perpendicular to rod
diosca aonfhoirmeach, ga r timpeall aise trí lárphointe ingearach leis an diosca	$\frac{1}{2} mr^2$	uniform disc, radius r about axis through centre perpendicular to disc
timpeall trastomhais	$\frac{1}{4} mr^2$	about diameter
fonsa aonfhoirmeach, ga r timpeall aise trí lárphointe ingearach leis an bhfoinse	mr^2	uniform hoop, radius r about axis through centre perpendicular to hoop
timpeall trastomhais	$\frac{1}{2} mr^2$	about diameter
sféar soladach aonfhoirmeach, ga r timpeall trastomhais	$\frac{2}{5} mr^2$	uniform solid sphere, radius r about diameter
teoirim na n-aiseanna comhthreomhara	$I_b = I_c + md^2$	parallel axis theorem
teoirim na n-aiseanna ingearacha	$I_z = I_x + I_y$	perpendicular axis theorem

Coirp rothlacha

móiminteam uilleach

$$L = I\omega = rmv$$

móimint fórsa

$$M = Fd$$

torc cúpla

$$T = Fd$$

dara dlí Newton don rothlú

$$T = \frac{dL}{dt}$$

fuinneamh cinéiteach rothlach

$$E = \frac{1}{2}I\omega^2$$

Gluaisne armónach shimplí

$$a = -\omega^2 s$$

$$T = \frac{1}{f} = \frac{2\pi}{\omega}$$

$$s = A \sin(\omega t + \alpha)$$

$$v^2 = \omega^2 (A^2 - s^2)$$

luascadán simplí

$$T = 2\pi\sqrt{\frac{l}{g}}$$

comhluascadán

$$T = 2\pi\sqrt{\frac{I}{mgh}}$$

Rotating bodies

angular momentum

moment of a force

torque of a couple

Newton's 2nd law for rotation

rotational kinetic energy

Simple harmonic motion

simple pendulum

compound pendulum

Fuinneamh agus obair		Energy and work
obair	$W = Fs = \int Fds$	work
cumhacht	$P = \frac{W}{t} = Fv$	power
céatadán éifeachtachta	$\frac{P_o \times 100}{P_i}$	percentage efficiency
fuinneamh poitéinsiúil (imtharraingthe)	$E_p = mgh$	potential energy (gravitational)
fuinneamh cinéiteach	$E_k = \frac{1}{2}mv^2$	kinetic energy
prionsabal imchoimeád an fhuinnimh (faoi fhórsaí meicniúla imchoimeádacha)	$\Delta E_p + \Delta E_k = 0$	principle of conservation of energy (under conservative mechanical forces)
coibhéis mhaise is fuinnimh	$E = mc^2$	mass-energy equivalence

Imtharraingt**Gravitation**

dlí imtharraingthe Newton

$$F = \frac{Gm_1m_2}{d^2}$$

Newton's law of gravitation

meáchan

$$W = mg = V\rho g$$

weight

luasghéarú de bharr
na domhantarraingthe

$$g = \frac{GM}{d^2}$$

acceleration due to gravity

neart réimse imtharraingthe

$$g = \frac{F}{m}$$

gravitational field strength

peiriad satailite

$$T^2 = \frac{4\pi^2 R^3}{GM}$$

period of a satellite



Fórsaí agus ábhair

dlí Hooke

$$F = -ks$$

strus

$$\sigma = \frac{F}{A}$$

straidhn

$$\varepsilon = \frac{\Delta l}{l}$$

modul Young

$$E = \frac{\sigma}{\varepsilon}$$

dlús

$$\rho = \frac{m}{V}$$

comhéifeacht na frithchuilte

$$\mu = \frac{F}{R}$$

brú

$$p = \frac{F}{A}$$

brú i leacht

$$p = \rho gh$$

sá ar dhromchla plánach tumtha

$$T = Ap_c$$

dlí Boyle

$$p \propto \frac{1}{V}$$

Forces and materials

Hooke's law

stress

strain

Young's modulus

density

coefficient of friction

pressure

pressure in a fluid

thrust on an immersed plane surface

Boyle's law



*Clár meicnic /
Mechanics contents*

Clár / Contents

Teas agus teocht

Heat and temperature

teocht Celsius	$\theta/^{\circ}\text{C} = T/\text{K} - 273.15$	Celsius temperature
an fuinneamh a theastaíonn chun teocht a athrú	$\Delta E = mc\Delta\theta \quad \Delta E = C\Delta\theta$	energy needed to change temperature
an fuinneamh a theastaíonn chun staid a athrú	$\Delta E = ml \quad \Delta E = L$	energy needed to change state
seoltacht theirmeach	$\frac{\Delta E}{\Delta t} = kA \frac{\Delta\theta}{\Delta l}$	thermal conductivity
friotachas teirmeach	$r = \frac{1}{k}$	thermal resistivity
R-luach (friotáíocht theirmeach)	$R = \frac{l}{k} = lr$	R-value (thermal resistance)
U-luach (tarchuras teirmeach)	$\frac{\Delta E}{\Delta t} = AU\Delta\theta$	U-value (thermal transmittance)
U-luach de bhacainn ilchodach	$U = \frac{1}{\Sigma R} \quad \frac{1}{U} = \frac{1}{U_1} + \frac{1}{U_2} + \dots$	U-value of a composite barrier

treoluas fuaim	$c = f\lambda$	velocity of a wave
iarmhairt Doppler	$f' = \frac{fc}{c \pm u}$	Doppler effect
minicíocht bhunúsach sreinge rite	$f = \frac{1}{2l} \sqrt{\frac{T}{\mu}}$	fundamental frequency of a stretched string
comhéifeacht athraonta	$n = \frac{c_1}{c_2}$	refractive index
gril díraonta	$n\lambda = d \sin \theta$	diffraction grating
fuinneamh fótóin	$E = hf$	energy of a photon
dlí fótaileictreach Einstein	$hf = \Phi + \frac{1}{2}mv_{\max}^2$; $\Phi = hf_0$	Einstein's photoelectric law

foirmle lionsa agus scannáin	$\frac{1}{f} = \frac{1}{u} + \frac{1}{v}$	mirror and lens formula
formhéadú	$m = \frac{v}{u}$	magnification
cumhacht lionsa	$P = \frac{1}{f}$	power of a lens
dhá lionsa thanai i dteagmháil le chéile	$P = P_1 + P_2$	two thin lenses in contact
comhéifeacht athraonta	$n = \frac{\sin i}{\sin r} = \frac{1}{\sin C}$	refractive index

dlí Coulomb	$F = \frac{1}{4\pi\epsilon} \frac{q_1 q_2}{d^2}$	Coulomb's law
neart réimse leictrigh	$E = \frac{F}{q}$	electric field strength
difríocht poitéinsil	$V = \frac{W}{q}$	potential difference
friotaíocht	$R = \frac{V}{I}$	resistance
friotachas	$\rho = \frac{RA}{l}$	resistivity
friotóirí i sraithcheangal	$R = R_1 + R_2$	resistors in series
friotóirí i dtreocheangal	$\frac{1}{R} = \frac{1}{R_1} + \frac{1}{R_2}$	resistors in parallel
droichead Wheatstone	$\frac{R_1}{R_2} = \frac{R_3}{R_4}$	Wheatstone bridge
dlí Joule	$P \propto I^2$	Joule's law



cumhacht (mheandrach)	$P = VI$	power (instantaneous)
fórsa ar sheoltóir sruthiompartha	$F = IlB; \quad l \perp B$	force on a current-carrying conductor
fórsa ar cháithnín luchtaithe	$F = qvB; \quad v \perp B$	force on a charged particle
flg ionductaithe	$E = -\frac{d\Phi}{dt}$	induced emf
voltas agus sruth ailtéarnach	$V_{\text{rms}} = \frac{V_0}{\sqrt{2}} \quad I_{\text{rms}} = \frac{I_0}{\sqrt{2}}$	alternating voltage and current
toilleas	$C = \frac{q}{V}$	capacitance
toilleoir plátaí comhthreomhara	$C = \frac{\epsilon_0 A}{d}$	parallel-plate capacitor
an fuinneamh atá stóráilte i dtoilleoir	$W = \frac{1}{2} CV^2$	energy stored in capacitor
flosc maighnéadach	$\Phi = BA$	magnetic flux
claochladán	$\frac{V_i}{V_o} = \frac{N_p}{N_s}$	transformer



Radaighníomhaíocht

Radioactivity

gníomhaíocht	$A = -\frac{dN}{dt}$	activity
dlí an mheatha radaighníomhaigh	$A = \lambda N$	law of radioactive decay
leath-ré	$T_{1/2} = \frac{\ln 2}{\lambda}$	half-life
coibhéis mhaise is fuinnimh	$E = mc^2$	mass-energy equivalence

Ceimic

Chemistry

teocht chaighdeánach	273.15 K	standard temperature
tríphointe an uisce	273.16 K	triple point of water
brú caighdeánach	1.01325×10^5 Pa	standard pressure
toirt mhólarach (ina lítir) ag brú agus teocht chaighdeánach	22.4	molar volume (in litres) at standard temperature and pressure
pH	$\text{pH} = -\log_{10}[\text{H}^+] = -\log_{10}[\text{H}_3\text{O}^+]$	pH
toradh ianach an uisce	$K_w = [\text{H}^+][\text{OH}^-] = [\text{H}_3\text{O}^+][\text{OH}^-]$	ionic product of water
cothromóid uilíoch an gháis	$pV = nRT = NkT$	universal gas equation
aonad maise (adamhaí)	1 u = $1.660\,5402 \times 10^{-27}$ kg	(atomic) mass unit

Siombailí do chainníochtaí fisiceacha coitianta agus na haonaid ina dtomhaistear iad

Symbols and units of measurement of common physical quantities

Braitheann brí siombailí áirithe ar an gcomhthéacs ina n-úsáidtear iad. In ord aibítire na siombailí atá an tábla. Tá na litreacha Gréigise chun deiridh.

The meaning of some symbols depends on the context in which they are used. The table is alphabetically ordered by symbol. Greek letters are at the end.

Cainníocht	Siombail Symbol	Aonad SI SI unit	Quantity
luasghéarú	<i>a</i>	m s^{-2}	acceleration
gníomhaíocht	<i>A</i>	Bq	activity
aimplitiúid	<i>A</i>	m	amplitude
achar	<i>A</i>	m^2	area
maisuumhir	<i>A</i>	kg	mass number
mais adamhach choibhneasta	<i>A_r</i>		relative atomic mass
floscdhlús maighnéadach	<i>B</i>	T	magnetic flux density
tiúchan	<i>c</i>	mol m^{-3}	concentration
sainoilleadh teasa	<i>c</i>	$\text{J kg}^{-1} \text{K}^{-1}$	specific heat capacity
luas an tsolais	<i>c</i>	m s^{-1}	speed of light
luas an tsolais <i>in vacuo</i>	<i>c₀</i>	m s^{-1}	speed of light <i>in vacuo</i>



Cainníocht	Siombail Symbol	Aonad SI SI unit	Quantity
toilleas	C	F	capacitance
uillinn chriticiúil	C		critical angle
toilleadh teasa	C	J K^{-1}	heat capacity
fad slí	d	m	distance
dáileog ionsúite	D	Gy	absorbed dose
lucht leictreonach	e	C	electronic charge
comhéifeacht an chúitimh	e		coefficient of restitution
fuinneamh gníomhachtúcháin	E	J mol^{-1}	activation energy
neart réimse leictrigh	E	V m^{-1}	electric field strength
flg (fórsa leictreaghluaisneach)	E	V	emf (electromotive force)
fuinneamh	E	J	energy
modal Young	E	N m^{-2}	Young's modulus
fuinneamh (cinéiteach)	E_k	J	energy (kinetic)
fuinneamh (poitéinsiúil)	E_p	J	energy (potential)
fad fócasach	f	m	focal length
minicíocht	f	Hz	frequency
minicíocht tairsí	f_0	Hz	threshold frequency

Cainníocht	Siombail Symbol	Aonad SI SI unit	Quantity
tairiseach Faraday	<i>F</i>	C mol ⁻¹	Faraday constant
fórsa	<i>F</i>	N	force
luasghéarú de bharr na domhantarraingthe	<i>g</i>	m s ⁻²	acceleration due to gravity
tairiseach na himtharraingthe	<i>G</i>	m ³ kg ⁻¹ s ⁻²	gravitational constant
tairiseach Planck	<i>h</i>	J s	Planck constant
coibhéis dháileogach	<i>H</i>	Sv	dose equivalent
eantalpacht	<i>H</i>	J mol ⁻¹	enthalpy
neart réimse mhaighnéadaigh	<i>H</i>	A m ⁻¹	magnetic field strength
sruth leictreach	<i>I</i>	A	electric current
ríog	<i>I</i>	N s	impulse
móimint na taimhe	<i>I</i>	kg m ²	moment of inertia
fuaimdhéine	<i>I</i>	W m ⁻²	sound intensity
leibhéal fuaimdhéine	<i>I.L.</i>		sound intensity level
déine lonrúil	<i>I_v</i>	cd	luminous intensity
tairiseach (cineálach)	<i>k</i>		constant (generic)
tairiseach Boltzmann	<i>k</i>	J K ⁻¹	Boltzmann constant
seoltacht theirmeach	<i>k</i>	W m ⁻¹ K ⁻¹	thermal conductivity

Cainníocht	Siombail Symbol	Aonad SI SI unit	Quantity
toradh ianach an uisce	K_w	$\text{mol}^2 \text{m}^{-6}$	ionic product of water
fad	l	m	length
móiminteam uilleach	L	J s	angular momentum
teas folaigh	L	J	latent heat
uathionductas	L	H	self inductance
formhéadú	m		magnification
mais	m	kg	mass
mólaracht	M	mol m^{-3}	molarity
móimint fórsa	M	N m	moment of a force
comhionductas	M	H	mutual inductance
mais mhóilíneach choibhneasta	M_r		relative molecular mass
méid substainte	n	mol	amount of substance
comhéifeacht athraonta	n		refractive index
líon cáithníní	N		number of particles
líon cor	N		number of turns
tairiseach Avogadro	N_A	mol^{-1}	Avogadro constant
neart poil mhaighnéadaigh	p	Wb	magnetic pole strength

Cainníocht	Siombail Symbol	Aonad SI SI unit	Quantity
móiminteam	p	kg m s^{-1}	momentum
brú	p, P	Pa	pressure
cumhacht	P	W	power
lucht	q	C	charge
fuinneamh (teas)	Q	J	energy (heat)
friotachas teirmeach	r	K m W^{-1}	thermal resistivity
frithghníomhú normalach	R	N	normal reaction
friotachas	R	Ω	resistance
ga	r, R	m	radius
R-luach (friotaíocht theirmeach)	R	$\text{K m}^2 \text{W}^{-1}$	R-value (thermal resistance)
tairiseach uilíoch gáis	R	$\text{J K}^{-1} \text{mol}^{-1}$	universal gas constant
díláithriú, fad	s	m	displacement, distance
am	t	s	time
teocht Celsius	t, θ	$^{\circ}\text{C}$	Celsius temperature
am tréimhsiúil	T	s	periodic time
teocht	T	K	temperature
teannas	T	N	tension

Cainníocht	Siombail Symbol	Aonad SI SI unit	Quantity
torc	T	N m	torque
leathré	$T_{1/2}$	s	half-life
U-luach (tarchuras teirmeach)	U	$\text{W m}^{-2} \text{K}^{-1}$	U-value (thermal transmittance)
luas, treoluas	u	m s^{-1}	speed, velocity
luas, treoluas	v	m s^{-1}	speed, velocity
difríocht poitéinsil (voltas)	V	V	potential difference (voltage)
toirt	V	m^3	volume
fuinneamh (leictreach)	W	J	energy (electrical)
meáchan	W	N	weight
obair	W	J	work
uimhir adamhach	Z		atomic number
athrú teochta	$\Delta\theta$	K	change in temperature
ceadaíocht	ϵ	F m^{-1}	permittivity
ceadaíocht an tsaorspáis	ϵ_0	F m^{-1}	permittivity of free space
straidhn	ϵ		strain
uillinn	θ	rad	angle

Cainníocht	Siombail Symbol	Aonad SI SI unit	Quantity
teocht Celsius	θ	$^{\circ}\text{C}$	Celsius temperature
tonnfhad	λ	m	wavelength
comhéifeacht na frithchuimilte	μ		coefficient of friction
tréscailteacht	μ	H m^{-1}	permeability
tréscailteacht an tsaorspáis	μ_0	H m^{-1}	permeability of free space
dlús	ρ	kg m^{-3}	density
friotachas	ρ	$\Omega \text{ m}$	resistivity
strus	σ	Pa	stress
flosc maighnéadach	Φ	Wb	magnetic flux
feidhm oibre	Φ	J	work function
treoluas uilleach	ω	rad s^{-1}	angular velocity
uillinn sholadach	Ω	sr	solid angle



Siombailí ciorcaid leictrigh





Lasca	72
Seoltóirí	73
Soáthar cumhachta	73
Friotóirí	74
Toilleoirí	74
Dé-óidí	75
Méadair	75
Trasraitheoirí agus aimpliú	76
Fuaim	76
Lampaí	77
Feistí eile	77

Electrical circuit symbols

Switches
Conductors
Power supply
Resistors
Capacitors
Diodes
Meters
Transistors & amplification
Audio
Lamps
Other devices

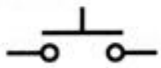

Lasca

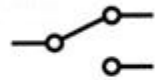
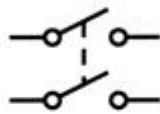
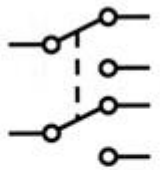
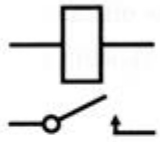
Switches

<p>sá-lasc chun ceangail</p>  <p>push-to-make switch</p>	<p>sá-lasc chun gearrtha</p>  <p>push-to-break switch</p>	<p>lasc gnáthoscailte (lasc aon phoil aon bhealaigh) (SPST)</p>  <p>normally open switch (single-pole single-throw switch) (SPST)</p>	<p>lasc gnáthdhúnta (SPST)</p>  <p>normally closed switch (SPST)</p>
<p>lasc dhá bhealach (lasc aon phoil dhébhealaigh) (SPDT)</p>  <p>two-way switch (single-pole double- throw switch) (SPDT)</p>	<p>lasc phoil dhúbailte aon bhealaigh (DPST)</p>  <p>double-pole single-throw switch (DPST)</p>	<p>lasc phoil dhúbailte dhébhealaigh (DPDT)</p>  <p>double-pole double-throw switch (DPDT)</p>	<p>athsheachadán</p>  <p>relay</p>







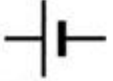

Seoltóirí

cumar seoltóirí  junction of conductors	seoltóirí ag trasnú a chéile gan cheangal  conductors crossing with no connection
--	--

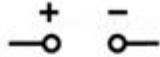
Conductors

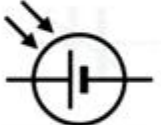
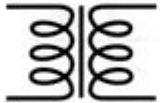



Soláthar cumhachta

cill  cell	ceallra  battery	soláthar s.d.  d.c. supply	soláthar s.a.  a.c. supply
cill fhótavoltach  photovoltaic cell	claochladán  transformer	fiús  fuse	talmhú  earth

Power supply

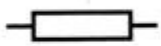

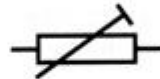
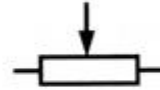

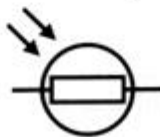
Friotóirí

Resistors

<p>friotóir fosaithe</p>  <p>fixed resistor</p>	<p>friotóir inathraithe (réastat)</p>  <p>variable resistor (rheostat)</p>	<p>friotóir inathraithe réamshocraithe</p>  <p>preset variable resistor</p>	<p>roinnteoir poitéinsil</p>  <p>potential divider</p>
<p>teirmeastar</p>  <p>thermistor</p>	<p>friotóir solas-spleách</p>  <p>light-dependent resistor</p>		



Toilleoirí

Capacitors

<p>toilleoir</p>  <p>capacitor</p>	<p>toilleoir leictrealaíoch (toilleoir polaraithe)</p>  <p>electrolytic capacitor (polarised capacitor)</p>	<p>toilleoir inathraithe</p>  <p>variable capacitor</p>	<p>toilleoir inathraithe réamshocraithe</p>  <p>preset variable capacitor</p>
---	--	---	--



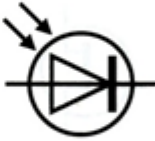
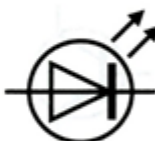

Dé-óidí

Diodes

dé-óid  diode	dé-óid Zener  Zener diode	fótaidhé-óid  photodiode	dé-óid astaithe solais (LED)  light-emitting diode (LED)
--	--	--	---

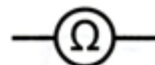

Méadair

Meters

voltmhéadar  voltmeter	galbhánaiméadar  galvanometer	aimpmhéadar  ammeter	óm-mhéadar  ohmmeter
ascalascóp  oscilloscope			





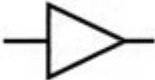

Trasraitheoirí agus aimplíú

Transistors and amplification

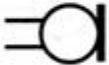
trasraitheoir cumair npn  npn-junction transistor	trasraitheoir tionchar réimse n-chainéil (JFET)  n-channel field-effect transistor (JFET)	fótathrasraitheoir  phototransistor	aimplitheoir  amplifier
--	--	---	--

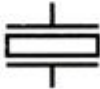

Fuaim

Audio

micreafón  microphone	cluasán  earphone	callaire  loudspeaker	cloigin  bell
dordánaí  buzzer	trasduchtóir píseleictreach  piezoelectric transducer	aeróg  aerial (antenna)	



Lampaí

Lamps

<p>lampa filiméid</p>  <p>filament lamp</p>	<p>lampa comhartha</p>  <p>signal lamp</p>	<p>lampa neoin</p>  <p>neon lamp</p>
--	---	--



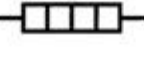
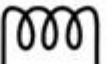



Feistí eile

Other devices

<p>mótar</p>  <p>motor</p>	<p>téitheoir</p>  <p>heater</p>	<p>ionductóir</p>  <p>inductor</p>	<p>ionductóir le croileacán fearómaighnéadach</p>  <p>inductor with ferromagnetic core</p>
---	--	--	---

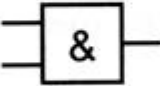
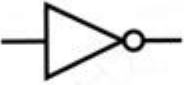
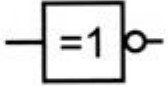
Geataí loighce

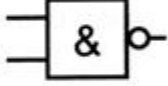
Logic gates

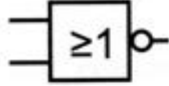
  OR	  AND	  NOT (<i>inbhéartóir / inverter</i>)	  NAND
  NOR			



Na dúile

Tábla peiriadach
na ndúl

79

**Fuinneamh céadianúcháin
na ndúl**

80

Luachanna leictridhiúltachta
na ndúl

81

**An tSraith Lantanóideach agus
an tSraith Achtanóideach**

82

The elements

Periodic table
of the elements

**First ionisation energies
of the elements**

Electronegativity values
of the elements

**The Lanthanoid and
the Actinoid Series**

Clár / Contents

Tábla peiriadach na ndúl

Periodic table of the elements

1											18						
1 H 1.008											2 He 4.003						
3 Li 6.941	4 Be 9.012											5 B 10.81	6 C 12.01	7 N 14.01	8 O 16.00	9 F 19.00	10 Ne 20.18
11 Na 22.99	12 Mg 24.31	13 Al 26.98	14 Si 28.09	15 P 30.97	16 S 32.07	17 Cl 35.45	18 Ar 39.95										
19 K 39.10	20 Ca 40.08	21 Sc 44.96	22 Ti 47.87	23 V 50.94	24 Cr 52.00	25 Mn 54.94	26 Fe 55.85	27 Co 58.93	28 Ni 58.69	29 Cu 63.55	30 Zn 65.41	31 Ga 69.72	32 Ge 72.64	33 As 74.92	34 Se 78.96	35 Br 79.90	36 Kr 83.80
37 Rb 85.47	38 Sr 87.62	39 Y 88.91	40 Zr 91.22	41 Nb 92.91	42 Mo 95.94	43 Tc (97.91)	44 Ru 101.1	45 Rh 102.9	46 Pd 106.4	47 Ag 107.9	48 Cd 112.4	49 In 114.8	50 Sn 118.7	51 Sb 121.8	52 Te 127.6	53 I 126.9	54 Xe 131.3
55 Cs 132.9	56 Ba 137.3	57 La 138.9	72 Hf 178.5	73 Ta 180.9	74 W 183.8	75 Re 186.2	76 Os 190.2	77 Ir 192.2	78 Pt 195.1	79 Au 197.0	80 Hg 200.6	81 Tl 204.4	82 Pb 207.2	83 Bi 209.0	84 Po (209.0)	85 At (210.0)	86 Rn (222.0)
87 Fr (223.0)	88 Ra (226.0)	89 Ac (227.0)	104 Rf (261.1)	105 Db (262.1)	106 Sg (266.1)	107 Bh (264.1)	108 Hs (277.0)	109 Mt (268.1)	110 Ds (271.0)	111 Rg (272.2)	112 Uub (285.0)	113 Uut (284)	114 Uuq (289.0)	115 Uup (288)	116 Uuh (289.0)	117 Uus*	118 Uuo (293.0)

* Níor braitheadh an dúil seo go fóill (2009).

Ar lch 82 atá an tSraith Lantanóideach agus an tSraith Achtanóideach.
Cuireann na lúbíní in iúl nach bhfuil iseatóp cobhsaí ag an dúil.

* This element has not yet been detected (2009).

See page 82 for the Lanthanoid and the Actinoid Series.
Brackets indicate that the element has no stable isotope.



Fuinneamh céadianúcháin na ndúl

(ina kJ mol⁻¹)

First ionisation energies of the elements

(in kJ mol⁻¹)

1												18					
1	2											2					
1 H 1312																	
3 Li 520	4 Be 900											5 B 801	6 C 1086	7 N 1402	8 O 1314	9 F 1681	10 Ne 2081
11 Na 496	12 Mg 738	3	4	5	6	7	8	9	10	11	12	13 Al 578	14 Si 789	15 P 1012	16 S 1000	17 Cl 1251	18 Ar 1521
19 K 419	20 Ca 590	21 Sc 631	22 Ti 658	23 V 650	24 Cr 653	25 Mn 717	26 Fe 759	27 Co 758	28 Ni 737	29 Cu 746	30 Zn 906	31 Ga 579	32 Ge 762	33 As 947	34 Se 941	35 Br 1140	36 Kr 1351
37 Rb 403	38 Sr 550	39 Y 616	40 Zr 660	41 Nb 665	42 Mo 685	43 Tc 702	44 Ru 711	45 Rh 720	46 Pd 805	47 Ag 731	48 Cd 868	49 In 558	50 Sn 709	51 Sb 834	52 Te 869	53 I 1008	54 Xe 1170
55 Cs 376	56 Ba 503	57 La 538	72 Hf 680	73 Ta 761	74 W 770	75 Re 760	76 Os 840	77 Ir 880	78 Pt 870	79 Au 890	80 Hg 1007	81 Tl 589	82 Pb 716	83 Bi 703	84 Po 812	85 At 890±40	86 Rn 1037
87 Fr 380	88 Ra 509	89 Ac 499	104 Rf 580	105 Db --	106 Sg --	107 Bh --	108 Hs --	109 Mt --	110 Ds --	111 Rg --	112 Uub --	113 Uut --	114 Uuq --	115 Uup --	116 Uuh --	117 Uus* --	118 Uuo --

Ar lech 82 atá an tSraith Lantanóideach agus an tSraith Achtanóideach.

See page 82 for the Lanthanoid and the Actinoid Series.

Luachanna leictridhiúltachta na ndúl

(Ag baint úsáid as scála Pauling)

Electronegativity values of the elements

(Using the Pauling scale)

1																	18
1 H 2.20																	2 He --
3 Li 0.98	4 Be 1.57											5 B 2.04	6 C 2.55	7 N 3.04	8 O 3.44	9 F 3.98	10 Ne --
11 Na 0.93	12 Mg 1.31											13 Al 1.61	14 Si 1.90	15 P 2.19	16 S 2.58	17 Cl 3.16	18 Ar --
19 K 0.82	20 Ca 1.00	21 Sc 1.36	22 Ti 1.54	23 V 1.63	24 Cr 1.66	25 Mn 1.55	26 Fe 1.83	27 Co 1.88	28 Ni 1.91	29 Cu 1.90	30 Zn 1.65	31 Ga 1.81	32 Ge 2.01	33 As 2.18	34 Se 2.55	35 Br 2.96	36 Kr --
37 Rb 0.82	38 Sr 0.95	39 Y 1.22	40 Zr 1.33	41 Nb 1.60	42 Mo 2.16	43 Tc 2.10	44 Ru 2.20	45 Rh 2.28	46 Pd 2.20	47 Ag 1.93	48 Cd 1.69	49 In 1.78	50 Sn 1.96	51 Sb 2.05	52 Te 2.10	53 I 2.66	54 Xe 2.60
55 Cs 0.79	56 Ba 0.89	57 La 1.10	72 Hf 1.30	73 Ta 1.50	74 W 1.70	75 Re 1.90	76 Os 2.20	77 Ir 2.20	78 Pt 2.20	79 Au 2.40	80 Hg 1.90	81 Tl 1.80	82 Pb 1.80	83 Bi 1.90	84 Po 2.00	85 At 2.20	86 Rn --
87 Fr 0.70	88 Ra 0.90	89 Ac 1.10	104 Rf --	105 Db --	106 Sg --	107 Bh --	108 Hs --	109 Mt --	110 Ds --	111 Rg --	112 Uub --	113 Uut --	114 Uuq --	115 Uup --	116 Uuh --	117 Uus* --	118 Uuo --

Ar lch 82 atá an tSraith Lantanóideach agus an tSraith Achtanóideach.

See page 82 for the Lanthanoid and the Actinoid Series.

Tábla peiriadach na ndúl

Periodic table of the elements

<i>An tSraith Lantanóideach</i> Lanthanoid Series	58 Ce 140.1	59 Pr 140.9	60 Nd 144.2	61 Pm (144.9)	62 Sm 150.4	63 Eu 152.0	64 Gd 157.3	65 Tb 158.9	66 Dy 162.5	67 Ho 164.9	68 Er 167.3	69 Tm 168.9	70 Yb 173.0	71 Lu 175.0
<i>An tSraith Achtanóideach</i> Actinoid Series	90 Th 232.0	91 Pa 231.0	92 U 238.0	93 Np (237.0)	94 Pu (244.1)	95 Am (243.1)	96 Cm (247.1)	97 Bk (247.1)	98 Cf (251.1)	99 Es (252.1)	100 Fm (257.1)	101 Md (258.1)	102 No (259.1)	103 Lr (262.1)

Cuireann na lúbíní in iúl nach bhfuil iseatóp cobhsaí ag an dúil.

Brackets indicate that the element has no stable isotope.

Fuinneamh céadianúcháin na ndúl

First ionisation energies of the elements

(ina kJ mol⁻¹)

(in kJ mol⁻¹)

<i>An tSraith Lantanóideach</i> Lanthanoid Series	58 Ce 534	59 Pr 527	60 Nd 533	61 Pm 540	62 Sm 545	63 Eu 547	64 Gd 593	65 Tb 566	66 Dy 573	67 Ho 581	68 Er 589	69 Tm 597	70 Yb 603	71 Lu 524
<i>An tSraith Achtanóideach</i> Actinoid Series	90 Th 587	91 Pa 568	92 U 598	93 Np 605	94 Pu 581	95 Am 576	96 Cm 581	97 Bk 601	98 Cf 608	99 Es 619	100 Fm 627	101 Md 635	102 No 642	103 Lr 470

Luachanna leictridhiúltachta na ndúl

Electronegativity values of the elements

(Ag baint úsáid as scála Pauling)

(Using the Pauling scale)

<i>An tSraith Lantanóideach</i> Lanthanoid Series	58 Ce 1.12	59 Pr 1.13	60 Nd 1.14	61 Pm --	62 Sm 1.17	63 Eu --	64 Gd 1.20	65 Tb --	66 Dy 1.22	67 Ho 1.23	68 Er 1.24	69 Tm 1.25	70 Yb --	71 Lu 1.00
<i>An tSraith Achtanóideach</i> Actinoid Series	90 Th 1.30	91 Pa 1.50	92 U 1.70	93 Np 1.30	94 Pu 1.30	95 Am 1.30	96 Cm 1.30	97 Bk 1.30	98 Cf 1.30	99 Es 1.30	100 Fm 1.30	101 Md 1.30	102 No 1.30	103 Lr 1.30



Tábla na núiclídí

Table of nuclides

Liosta atá sa tábla de mhaiseanna na núiclídí cobhsaí agus de mhaiseanna na n-iseatóp is fadsaolaí de na núiclídí éagobhsaí. Tugtar céatadán líonmhaireachta nádúrtha na núiclídí cobhsaí agus leathré na n-iseatóp is fadsaolaí de na núiclídí éagobhsaí. Tugtar sonraí breise i gcomhair an úráiniam.

The table lists the mass of the stable nuclides and that of the longest-lived isotope of the unstable nuclides. The percentage natural abundance is given for the stable nuclides and the half-life is given for the longest-lived isotope of the unstable nuclides. Additional information is given for uranium.

Z	siombail symbol	mais adaimh mass of atom (u)	líonmhaireacht abundance (%)	leathré half-life
1	¹ H	1.007 825	99.9885	
	² H	2.014 102	0.0115	
	³ H	3.016 049	–	12.33 y
2	³ He	3.016 029	0.000134	
	⁴ He	4.002 603	99.999866	
3	⁶ Li	6.015 123	7.59	
	⁷ Li	7.016 005	92.41	
4	⁹ Be	9.012 182	100	
5	¹⁰ B	10.012 937	19.9	
	¹¹ B	11.009 305	80.1	
6	¹² C	12.000 000	98.93	
	¹³ C	13.003 355	1.07	
	¹⁴ C	14.003 242	–	5730 y
7	¹⁴ N	14.003 074	99.636	

Z	siombail symbol	mais adaimh mass of atom (u)	líonmhaireacht abundance (%)	leathré half-life
	¹⁵ N	15.000 109	0.364	
8	¹⁶ O	15.994 915	99.757	
	¹⁷ O	16.999 132	0.038	
	¹⁸ O	17.999 161	0.205	
9	¹⁹ F	18.998 403	100	
10	²⁰ Ne	19.992 440	90.48	
	²¹ Ne	20.993 847	0.27	
	²² Ne	21.991 385	9.25	
11	²³ Na	22.989 769	100	
12	²⁴ Mg	23.985 042	78.99	
	²⁵ Mg	24.985 837	10.00	
	²⁶ Mg	25.982 593	11.01	
13	²⁷ Al	26.981 538	100	
14	²⁸ Si	27.976 927	92.223	



Z	siombail symbol	mais adainh mass of atom (u)	líonmhairacht abundance (%)	leathré half-life
	²⁹ Si	28.976 495	4.685	
	³⁰ Si	29.973 770	3.092	
15	³¹ P	30.973 762	100	
16	³² S	31.972 071	94.99	
	³³ S	32.971 458	0.75	
	³⁴ S	33.967 867	4.25	
	³⁶ S	35.967 081	0.01	
17	³⁵ Cl	34.968 853	75.76	
	³⁷ Cl	36.965 903	24.24	
18	³⁶ Ar	35.967 545	0.3365	
	³⁸ Ar	37.962 732	0.0632	
	⁴⁰ Ar	39.962 383	99.6003	
19	³⁹ K	38.963 707	93.2581	
	⁴⁰ K	39.963 999	0.0117	
	⁴¹ K	40.961 826	6.7302	
20	⁴⁰ Ca	39.962 591	96.941	
	⁴² Ca	41.958 618	0.647	
	⁴³ Ca	42.958 767	0.135	
	⁴⁴ Ca	43.955 482	2.086	
	⁴⁶ Ca	45.953 693	0.004	
	⁴⁸ Ca	47.952 534	0.187	

Z	siombail symbol	mais adainh mass of atom (u)	líonmhairacht abundance (%)	leathré half-life
21	⁴⁵ Sc	44.955 912	100	
22	⁴⁶ Ti	45.952 632	8.25	
	⁴⁷ Ti	46.951 763	7.44	
	⁴⁸ Ti	47.947 946	73.72	
	⁴⁹ Ti	48.947 870	5.41	
	⁵⁰ Ti	49.944 791	5.18	
23	⁵⁰ V	49.947 159	0.250	
	⁵¹ V	50.943 960	99.750	
24	⁵⁰ Cr	49.946 044	4.345	
	⁵² Cr	51.940 508	83.789	
	⁵³ Cr	52.940 649	9.501	
	⁵⁴ Cr	53.938 880	2.365	
25	⁵⁵ Mn	54.938 045	100	
26	⁵⁴ Fe	53.939 611	5.845	
	⁵⁶ Fe	55.934 938	91.754	
	⁵⁷ Fe	56.935 394	2.119	
	⁵⁸ Fe	57.933 276	0.282	
27	⁵⁹ Co	58.933 195	100	
28	⁵⁸ Ni	57.935 343	68.0769	
	⁶⁰ Ni	59.930 786	26.2231	
	⁶¹ Ni	60.931 056	1.1399	



Z	siombail symbol	mais adaimh mass of atom (u)	líonmhaireacht abundance (%)	leathré half-life
	⁶² Ni	61.928 345	3.6345	
	⁶⁴ Ni	63.927 966	0.9256	
29	⁶³ Cu	62.929 598	69.15	
	⁶⁵ Cu	64.927 790	30.85	
30	⁶⁴ Zn	63.929 142	48.268	
	⁶⁶ Zn	65.926 033	27.975	
	⁶⁷ Zn	66.927 127	4.102	
	⁶⁸ Zn	67.924 844	19.024	
	⁷⁰ Zn	69.925 319	0.631	
31	⁶⁹ Ga	68.925 574	60.108	
	⁷¹ Ga	70.924 701	39.892	
32	⁷⁰ Ge	69.924 247	20.38	
	⁷² Ge	71.922 076	27.31	
	⁷³ Ge	72.923 459	7.76	
	⁷⁴ Ge	73.921 178	36.72	
	⁷⁶ Ge	75.921 403	7.83	
33	⁷⁵ As	74.921 597	100	
34	⁷⁴ Se	73.922 476	0.89	
	⁷⁶ Se	75.919 214	9.37	
	⁷⁷ Se	76.919 914	7.63	
	⁷⁸ Se	77.917 309	23.77	

Z	siombail symbol	mais adaimh mass of atom (u)	líonmhaireacht abundance (%)	leathré half-life
	⁸⁰ Se	79.916 521	49.61	
	⁸² Se	81.916 700	8.73	
35	⁷⁹ Br	78.918 337	50.69	
	⁸¹ Br	80.916 291	49.31	
36	⁷⁸ Kr	77.920 365	0.355	
	⁸⁰ Kr	79.916 379	2.286	
	⁸² Kr	81.913 484	11.593	
	⁸³ Kr	82.914 136	11.500	
	⁸⁴ Kr	83.911 507	56.987	
	⁸⁶ Kr	85.910 611	17.279	
37	⁸⁵ Rb	84.911 790	72.17	
	⁸⁷ Rb	86.909 181	27.83	
38	⁸⁴ Sr	83.913 425	0.56	
	⁸⁶ Sr	85.909 260	9.86	
	⁸⁷ Sr	86.908 877	7.00	
	⁸⁸ Sr	87.905 612	82.58	
39	⁸⁹ Y	88.905 848	100	
40	⁹⁰ Zr	89.904 704	51.45	
	⁹¹ Zr	90.905 645	11.22	
	⁹² Zr	91.905 041	17.15	
	⁹⁴ Zr	93.906 315	17.38	



Z	siombail symbol	mais adaimh mass of atom (u)	lionmhaireacht abundance (%)	leathré half-life
	⁹⁶ Zr	95.908 273	2.80	
41	⁹³ Nb	92.906 378	100	
42	⁹² Mo	91.906 811	14.77	
	⁹⁴ Mo	93.905 088	9.23	
	⁹⁵ Mo	94.905 842	15.90	
	⁹⁶ Mo	95.904 680	16.68	
	⁹⁷ Mo	96.906 020	9.56	
	⁹⁸ Mo	97.905 408	24.19	
	¹⁰⁰ Mo	99.907 477	9.67	
43	⁹⁸ Tc	97.907 216	–	4.2 × 10 ⁶ y
44	⁹⁶ Ru	95.907 598	5.54	
	⁹⁸ Ru	97.905 287	1.87	
	⁹⁹ Ru	98.905 939	12.76	
	¹⁰⁰ Ru	99.904 220	12.60	
	¹⁰¹ Ru	100.905 582	17.06	
	¹⁰² Ru	101.904 350	31.55	
	¹⁰⁴ Ru	103.905 433	18.62	
45	¹⁰³ Rh	102.905 504	100	
46	¹⁰² Pd	101.905 609	1.02	
	¹⁰⁴ Pd	103.904 036	11.14	
	¹⁰⁵ Pd	104.905 085	22.33	

Z	siombail symbol	mais adaimh mass of atom (u)	lionmhaireacht abundance (%)	leathré half-life
	¹⁰⁶ Pd	105.903 486	27.33	
	¹⁰⁸ Pd	107.903 892	26.46	
	¹¹⁰ Pd	109.905 153	11.72	
47	¹⁰⁷ Ag	106.905 097	51.839	
	¹⁰⁹ Ag	108.904 752	48.161	
48	¹⁰⁶ Cd	105.906 459	1.25	
	¹⁰⁸ Cd	107.904 184	0.89	
	¹¹⁰ Cd	109.903 002	12.49	
	¹¹¹ Cd	110.904 178	12.80	
	¹¹² Cd	111.902 758	24.13	
	¹¹³ Cd	112.904 402	12.22	
	¹¹⁴ Cd	113.903 359	28.73	
	¹¹⁶ Cd	115.904 756	7.49	
49	¹¹³ In	112.904 058	4.29	
	¹¹⁵ In	114.903 878	95.71	
50	¹¹² Sn	111.904 819	0.97	
	¹¹⁴ Sn	113.902 780	0.66	
	¹¹⁵ Sn	114.903 342	0.34	
	¹¹⁶ Sn	115.901 741	14.54	
	¹¹⁷ Sn	116.902 952	7.68	
	¹¹⁸ Sn	117.901 603	24.22	



Z	siombail symbol	mais adaimh mass of atom (u)	lionmhaireacht abundance (%)	leathré half-life
	¹¹⁹ Sn	118.903 308	8.59	
	¹²⁰ Sn	119.902 195	32.58	
	¹²² Sn	121.903 440	4.63	
	¹²⁴ Sn	123.905 274	5.79	
51	¹²¹ Sb	120.903 816	57.21	
	¹²³ Sb	122.904 214	42.79	
52	¹²⁰ Te	119.904 020	0.09	
	¹²² Te	121.903 044	2.55	
	¹²³ Te	122.904 270	0.89	
	¹²⁴ Te	123.902 818	4.74	
	¹²⁵ Te	124.904 431	7.07	
	¹²⁶ Te	125.903 312	18.84	
	¹²⁸ Te	127.904 463	31.74	
	¹³⁰ Te	129.906 224	34.08	
53	¹²⁷ I	126.904 473	100	
54	¹²⁴ Xe	123.905 893	0.0952	
	¹²⁶ Xe	125.904 274	0.0890	
	¹²⁸ Xe	127.903 531	1.9102	
	¹²⁹ Xe	128.904 779	26.4006	
	¹³⁰ Xe	129.903 508	4.0710	
	¹³¹ Xe	130.905 082	21.2324	

Z	siombail symbol	mais adaimh mass of atom (u)	lionmhaireacht abundance (%)	leathré half-life
	¹³² Xe	131.904 154	26.9086	
	¹³⁴ Xe	133.905 395	10.4357	
	¹³⁶ Xe	135.907 220	8.8573	
55	¹³³ Cs	132.905 452	100	
56	¹³⁰ Ba	129.906 321	0.106	
	¹³² Ba	131.905 061	0.101	
	¹³⁴ Ba	133.904 508	2.417	
	¹³⁵ Ba	134.905 687	6.592	
	¹³⁶ Ba	135.904 576	7.854	
	¹³⁷ Ba	136.905 827	11.232	
	¹³⁸ Ba	137.905 247	71.698	
57	¹³⁸ La	137.907 112	0.090	
	¹³⁹ La	138.906 353	99.910	
58	¹³⁶ Ce	135.907 172	0.185	
	¹³⁸ Ce	137.905 991	0.251	
	¹⁴⁰ Ce	139.905 439	88.450	
	¹⁴² Ce	141.909 244	11.114	
59	¹⁴¹ Pr	140.907 643	100	
60	¹⁴² Nd	141.907 723	27.2	
	¹⁴³ Nd	142.909 814	12.2	
	¹⁴⁴ Nd	143.910 088	23.8	



Z	siombail symbol	mais adaimh mass of atom (u)	lionmhaireacht abundance (%)	leathré half-life
	¹⁴⁵ Nd	144.912 574	8.3	
	¹⁴⁶ Nd	145.913 117	17.2	
	¹⁴⁸ Nd	147.916 893	5.7	
	¹⁵⁰ Nd	149.920 891	5.6	
61	¹⁴⁵ Pm	144.912 744	–	17.7 y
62	¹⁴⁴ Sm	143.911 999	3.07	
	¹⁴⁷ Sm	146.914 898	14.99	
	¹⁴⁸ Sm	147.914 823	11.24	
	¹⁴⁹ Sm	148.917 185	13.82	
	¹⁵⁰ Sm	149.917 276	7.38	
	¹⁵² Sm	151.919 732	26.75	
	¹⁵⁴ Sm	153.922 209	22.75	
63	¹⁵¹ Eu	150.919 850	47.81	
	¹⁵³ Eu	152.921 230	52.19	
64	¹⁵² Gd	151.919 791	0.20	
	¹⁵⁴ Gd	153.920 866	2.18	
	¹⁵⁵ Gd	154.922 622	14.80	
	¹⁵⁶ Gd	155.922 123	20.47	
	¹⁵⁷ Gd	156.923 960	15.65	
	¹⁵⁸ Gd	157.924 104	24.84	
	¹⁶⁰ Gd	159.927 054	21.86	

Z	siombail symbol	mais adaimh mass of atom (u)	lionmhaireacht abundance (%)	leathré half-life
65	¹⁵⁹ Tb	158.925 347	100	
66	¹⁵⁶ Dy	155.924 283	0.056	
	¹⁵⁸ Dy	157.924 409	0.095	
	¹⁶⁰ Dy	159.925 198	2.29	
	¹⁶¹ Dy	160.926 933	18.889	
	¹⁶² Dy	161.926 798	25.475	
	¹⁶³ Dy	162.928 731	24.896	
	¹⁶⁴ Dy	163.929 175	28.260	
67	¹⁶⁵ Ho	164.930 322	100	
68	¹⁶² Er	161.928 778	0.139	
	¹⁶⁴ Er	163.929 200	1.601	
	¹⁶⁶ Er	165.930 293	33.503	
	¹⁶⁷ Er	166.932 048	22.869	
	¹⁶⁸ Er	167.932 370	26.978	
	¹⁷⁰ Er	169.935 464	14.910	
69	¹⁶⁹ Tm	168.934 213	100	
70	¹⁶⁸ Yb	167.933 897	0.13	
	¹⁷⁰ Yb	169.934 762	3.04	
	¹⁷¹ Yb	170.936 326	14.28	
	¹⁷² Yb	171.936 382	21.83	
	¹⁷³ Yb	172.938 211	16.13	



Z	siombail symbol	mais adaimh mass of atom (u)	lionmhaireacht abundance (%)	leathré half-life
	¹⁷⁴ Yb	173.938 862	31.83	
	¹⁷⁶ Yb	175.942 572	12.76	
71	¹⁷⁵ Lu	174.940 772	97.41	
	¹⁷⁶ Lu	175.942 686	2.59	
72	¹⁷⁴ Hf	173.940 046	0.16	
	¹⁷⁶ Hf	175.941 409	5.26	
	¹⁷⁷ Hf	176.943 221	18.60	
	¹⁷⁸ Hf	177.943 699	27.28	
	¹⁷⁹ Hf	178.945 816	13.62	
	¹⁸⁰ Hf	179.946 550	35.08	
73	¹⁸⁰ Ta	179.947 465	0.012	
	¹⁸¹ Ta	180.947 996	99.988	
74	¹⁸⁰ W	179.946 704	0.12	
	¹⁸² W	181.948 204	26.50	
	¹⁸³ W	182.950 223	14.31	
	¹⁸⁴ W	183.950 931	30.64	
	¹⁸⁶ W	185.954 364	28.43	
75	¹⁸⁵ Re	184.952 955	37.40	
	¹⁸⁷ Re	186.955 753	62.60	
76	¹⁸⁴ Os	183.952 489	0.02	
	¹⁸⁶ Os	185.953 838	1.59	

Z	siombail symbol	mais adaimh mass of atom (u)	lionmhaireacht abundance (%)	leathré half-life
	¹⁸⁷ Os	186.955 751	1.96	
	¹⁸⁸ Os	187.955 838	13.24	
	¹⁸⁹ Os	188.958 148	16.15	
	¹⁹⁰ Os	189.958 447	26.26	
	¹⁹² Os	191.961 481	40.78	
77	¹⁹¹ Ir	190.960 594	37.3	
	¹⁹³ Ir	192.962 926	62.7	
78	¹⁹⁰ Pt	189.959 932	0.014	
	¹⁹² Pt	191.961 038	0.782	
	¹⁹⁴ Pt	193.962 680	32.967	
	¹⁹⁵ Pt	194.964 791	33.832	
	¹⁹⁶ Pt	195.964 952	25.242	
	¹⁹⁸ Pt	197.967 893	7.163	
79	¹⁹⁷ Au	196.966 569	100	
80	¹⁹⁶ Hg	195.965 833	0.15	
	¹⁹⁸ Hg	197.966 769	9.97	
	¹⁹⁹ Hg	198.968 280	16.87	
	²⁰⁰ Hg	199.968 326	23.10	
	²⁰¹ Hg	200.970 302	13.18	
	²⁰² Hg	201.970 643	29.86	
	²⁰⁴ Hg	203.973 494	6.87	



Z	siombail symbol	mais adaimh mass of atom (u)	lionmhaireacht abundance (%)	leathré half-life
81	²⁰³ Tl	202.972 344	29.52	
	²⁰⁵ Tl	204.974 428	70.48	
82	²⁰⁴ Pb	203.973 044	1.4	
	²⁰⁶ Pb	205.974 465	24.1	
	²⁰⁷ Pb	206.975 897	22.1	
	²⁰⁸ Pb	207.976 652	52.4	
83	²⁰⁹ Bi	208.980 379	100	
84	²⁰⁹ Po	208.982 430	–	103 y
85	²¹⁰ At	209.987 150	–	8.1 h
86	²²² Rn	222.017 578	–	3.824 d
87	²²³ Fr	223.019 736	–	22.0 min
88	²²⁶ Ra	226.025 410	–	1602 y
89	²²⁷ Ac	227.027 752	–	21.77 y
90	²³² Th	232.038 055	–	1.4×10^{10} y
91	²³¹ Pa	231.035 884	–	3.28×10^4 y
92	²³⁴ U	234.040 952	0.0054	2.46×10^6 y
	²³⁵ U	235.043 930	0.7204	7.04×10^8 y
	²³⁸ U	238.050 788	99.2742	4.47×10^9 y
93	²³⁷ Np	237.048 167	–	2.14×10^6 y
94	²⁴⁴ Pu	244.067 900	–	8.08×10^7 y
95	²⁴³ Am	243.061 381	–	7.37×10^3 y

Z	siombail symbol	mais adaimh mass of atom (u)	lionmhaireacht abundance (%)	leathré half-life
96	²⁴⁷ Cm	247.070 354	–	1.56×10^7 y
97	²⁴⁷ Bk	247.070 310	–	1.38×10^3 y
98	²⁵¹ Cf	251.079 587	–	898 y
99	²⁵² Es	252.082 980	–	1.29 y
100	²⁵⁷ Fm	257.095 110	–	100.5 d
101	²⁵⁸ Md	258.098 431	–	51.5 d
102	²⁵⁹ No	259.101 024	–	57 min
103	²⁶² Lr	262.1096	–	3.6 h
104	²⁶³ Rf	263.1126	–	10.0 min
105	²⁶² Db	262.1141	–	0.5 min
106	²⁶⁶ Sg	266.1221	–	~ 21 s
107	²⁶⁴ Bh	264.1246	–	1.0 s
108	²⁶⁹ Hs	269.1341	–	~ 14 s
109	²⁶⁸ Mt	268.1387	–	~ 42 ms
110	²⁷³ Ds	272.1489	–	118 ms
111	²⁷² Rg	272.1536	–	~ 2 ms
112	²⁸⁵ Uub	285.174	–	~ 34 s
113	²⁸⁴ Uut	284.178	–	~ 0.49 s
114	²⁸⁹ Uuq	289.187	–	~ 2.7 s
115	²⁸⁸ Uup	288.192	–	~ 87.5 ms
116	²⁹³ Uuh (293)	(293)	–	~ 0.05 s
118	²⁹⁴ Uuo (294)	(294)	–	~ 2.0 ms



Dúile, sórtáilte de réir na siombailí

Elements, sorted by symbol

Dúil	Siombail Symbol	Z	Element
achtainiam	Ac	89	actinium
airgead	Ag	47	silver
alúmanam	Al	13	aluminium
aimeiriciam	Am	95	americium
argón	Ar	18	argon
arsanaic	As	33	arsenic
astaitín	At	85	astatine
ór	Au	79	gold
bórón	B	5	boron
bairiam	Ba	56	barium
beirilliam	Be	4	beryllium
bóiriam	Bh	107	bohrium
biosmat	Bi	83	bismuth
beircéiliam	Bk	97	berkelium
bróimín	Br	35	bromine
carbón	C	6	carbon
cailciam	Ca	20	calcium
caidmiam	Cd	48	cadmium
ceiriam	Ce	58	cerium
calafoirniám	Cf	98	californium
clóirín	Cl	17	chlorine

Dúil	Siombail Symbol	Z	Element
ciúiriam	Cm	96	curium
cóbalt	Co	27	cobalt
cróimiam	Cr	24	chromium
caeisiam	Cs	55	caesium
copar	Cu	29	copper
deoitéiriam	D	1	deuterium
dúibniam	Db	105	dubnium
darmstaidiam	Ds	110	darmstadtium
diospróisiam	Dy	66	dysprosium
eirbiam	Er	68	erbium
éinstéiniam	Es	99	einsteinium
eoraipiam	Eu	63	europium
fluaírin	F	9	fluorine
iarann	Fe	26	iron
feirmiam	Fm	100	fermium
frainciam	Fr	87	francium
gailliam	Ga	31	gallium
gadailiniam	Gd	64	gadolinium
gearmáiniam	Ge	32	germanium
hidrigin	H	1	hydrogen
héiliam	He	2	helium



Dúil	Siombail Symbol	Z	Element
haifniam	Hf	72	hafnium
mearcair	Hg	80	mercury
hoilmiam	Ho	67	holmium
haisiam	Hs	108	hassium
iaidín	I	53	iodine
indiam	In	49	indium
iridiam	Ir	77	iridium
potaisiam	K	19	potassium
crioptón	Kr	36	krypton
lantanam	La	57	lanthanum
litiam	Li	3	lithium
láirinciam	Lr	103	lawrencium
lúitéitiam	Lu	71	lutetium
meindiléiviam	Md	101	mendelevium
maignéisiam	Mg	12	magnesium
mangainéis	Mn	25	manganese
molaibdéineam	Mo	42	molybdenum
meitniriam	Mt	109	meitnerium
nitrigin	N	7	nitrogen
sóidiam	Na	11	sodium
niaibiam	Nb	41	niobium
neoidimiam	Nd	60	neodymium
neon	Ne	10	neon

Dúil	Siombail Symbol	Z	Element
nicil	Ni	28	nickel
nóbailiam	No	102	nobelium
neiptiúiniam	Np	93	neptunium
ocsaigin	O	8	oxygen
oismiam	Os	76	osmium
fosfair	P	15	phosphorus
prótachtainiam	Pa	91	protactinium
luaidhe	Pb	82	lead
pallaidiam	Pd	46	palladium
próiméitiam	Pm	61	promethium
polóiniam	Po	84	polonium
praiséidimiam	Pr	59	praseodymium
platanam	Pt	78	platinum
plútóiniam	Pu	94	plutonium
raidiam	Ra	88	radium
rubaidiam	Rb	37	rubidium
réiniam	Re	75	rhenium
rutarfoirdiam	Rf	104	rutherfordium
rointginiam	Rg	111	roentgenium
róidiam	Rh	45	rhodium
radón	Rn	86	radon
ruitéiniam	Ru	44	ruthenium
sulfar	S	16	sulfur

Dúil	<i>Siombail</i> Symbol	Z	Element
antamón	Sb	51	antimony
scaindiam	Sc	21	scandium
seiléiniam	Se	34	selenium
seaboirgiam	Sg	106	seaborgium
sileacan	Si	14	silicon
samairiam	Sm	62	samarium
stán	Sn	50	tin
strointiam	Sr	38	strontium
tritiam	T	1	tritium
tantalam	Ta	73	tantalum
teirbiam	Tb	65	terbium
teicnéitiam	Tc	43	technetium
teallúiriam	Te	52	tellurium
tóiriam	Th	90	thorium
tíotáiniam	Ti	22	titanium
tailliam	Tl	81	thallium
túiliam	Tm	69	thulium
úrániam	U	92	uranium
únúinbiam	Uub	112	ununbium
únúinheicsiam	Uuh	116	ununhexium
únúnoichtiam	Uuo	118	ununoctium
únúinpeintiam	Uup	115	ununpentium
únúncuaidiam	Uuq	114	ununquadium

Dúil	<i>Siombail</i> Symbol	Z	Element
únúinseiptiam	Uus	117	ununseptium
únúintriám	Uut	113	ununtrium
vanaidiam	V	23	vanadium
tungstan	W	74	tungsten
xeanón	Xe	54	xenon
itriám	Y	39	yttrium
itéirbiam	Yb	70	ytterbium
sinc	Zn	30	zinc
siorcóiniam	Zr	40	zirconium



Please send any comments or suggestions for revisions to:

dfinlayson@eircom.net



Clár / Contents





Clár / Contents



I 618033988749894848204586834355638

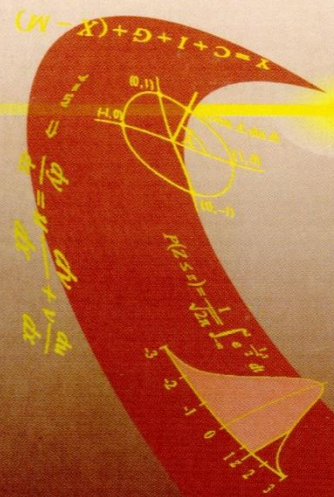

€4



Clár / Contents

